











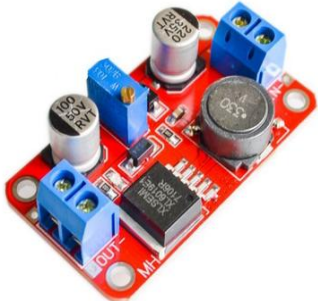









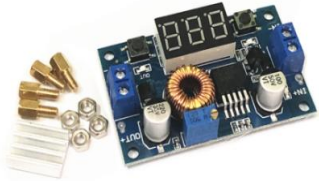



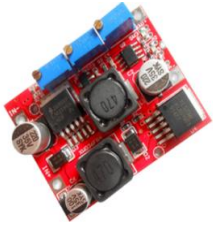

Power Module (DE)





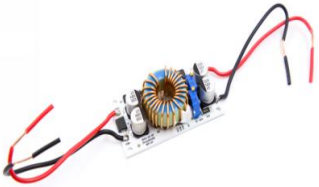

SKU	PICTURE	NAME	Weight (g)
AH015		<p>XH-M411 DC-DC Digital Booster Board Boost Nodule High-Power 5- 45V Output 5A</p>	
AH050		<p>20W XL6009 DC-DC Auto Boost Buck Adjustable Step Down Converter Module</p>	
AH051		<p>XL6019 5A DC-DC Auto Boost Buck Adjustable Step Down Converter Module</p>	
NA066		<p>MP1584EN Mini LM2596 ultra small DC-DC 3A power step-down adjustable module Buck Converter 24V turn 12v 9V 5V 3V</p>	
AA180		<p>MT3608 2A Max DC-DC Step Up Power Module Booster Power Module</p>	







AA306		<p>MT3608 XY-016 2A Max DC-DC Step Up Power Module Booster Power Module</p>	
AA166		<p>SX1308 Adjustable Power Supply Step-Up 28V 2A 1.2Mhz Booster Module DC</p>	
AA103		<p>Used Chip XL6009 DC-DC Booster Step-Up Module</p>	
AA670		<p>XL7015 DC-DC Converter Step Down Module</p>	
AA579		<p>XL4005 DC-DC 5-32V Adjustable Step Down 5A Buck Power Supply Module</p>	
AA270		<p>DC-DC XL4015 Adjustable Step-down Module 4~38V 5A 96% High Efficiency</p>	



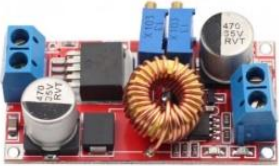



AA450		<p>Blue DC-DC XL4015 Adjustable Step-down Module 5A 75W</p>	
AA451		<p>DC-DC XL4015 Adjustable Step-down Module 5A 75W with 3 Bits Digital Display Voltmeter</p>	
AA452		<p>DC-DC XL4015 Adjustable Step-down Module 5A 75W with 4 Bits Digital Display Voltmeter</p>	
AA514		<p>XH-M401 DC-DC Step Down Buck Converter Power Supply Module XL4016E1</p>	
AA515		<p>XL4016E1 Step Down Power Supply Module DC4-40v to DC1.25-36V 8A 200W</p>	
AA516		<p>XH-M404 DC 4-40V 8A Voltage Regulator Module Digital PWM Adjustabl DC-DC Step Down Voltage Regulator DC XL4016E1</p>	







AA496		<p>48V36V24V to 19V12V9V5V3V Adjustable Synchronous Step-down Module / Car Charging Power Supply</p>	
AA476		<p>48V Adjustable Voltage Regulator Module DC-DC LM2596HVS Enter 4.5-60V</p>	
AA479		<p>Solar Energy Wind Belt Charging Constant Current Constant Voltage Power Supply Module LM2596 6019</p>	
AA263		<p>DC-DC Step-down Power Module 24v/12V to 5V 5A Power Module Better Than LM2596S</p>	
AA367		<p>24V/12V to 5V 5A Power Module DC-DC XY-3606 Power Converter Better Than LM2596S</p>	
NA065		<p>150W Boost Converter DC-DC 10-32V to 12-35V Step Up Voltage Charger Module</p>	







NA505		<p>300W 10A DC-DC Step-down Adjustable Constant Voltage Module</p>	
NA290		<p>200W DC-DC Boost Converter 6-35V to 6-55V 10A Step Up Voltage Charger Power with Shell</p>	
NA485		<p>Aluminum substrate Vehicle laptop power supply 250W high power boost constant current LED boost drive</p>	
NA501		<p>300W 20A DC-DC Buck Converter Step-down Module Constant Current LED Driver Power Step Down Voltage Module</p>	
NA680		<p>400WDC-DC High-Power Constant Voltage Constant Current Boost Power Module LED Boost Driver Laptop Battery Charging</p>	
NA503		<p>1200w DC DC Boost Step Up Converter 8-60V to 12-83V 20A For Car Laptop Solar Battery</p>	





NA291		<p>12V 300mA Power Supply Module Low Power 12V 0.4A, 5W LED Constant Voltage</p>	
NA292		<p>Precision 5V 700mA (3.5W) Isolation Power Supply Module AC-DC Step-Down Module 220V to 5V</p> <p>Note:The Color of PCB is</p>	
NA293		<p>Precision 12V 450mA (5W) power Supply Module Bare Board, LED Voltage Regulator Module AC 220V to 12V</p> <p>Note:The Color of PCB is</p>	
AA691		<p>DC-DC USB Boost Power Regulator Module 5V to 3.3V 9V 12V 24V Desktop Power Module</p>	
AA197		<p>Multi Output Voltage DC-DC 12V to 3.3V 5V 12V Power Module</p>	
NA463		<p>DC-DC High Power Adjustable Step-up Module 3.0~35V to 3.5~35V 100W with Digital Display Voltmeter</p>	







AA369		<p>Large Current 5A Constant Current Constant Voltage LED Drives Lithium Battery Charging XL4015 Module</p>	
AA449 =AA369		<p>Red DC-DC XL4015 Adjustable Step-down Module 5A 75W</p>	
NA529		<p>HLK-PM01 AC-DC Power Supply Module 220v to 5v</p>	
NA530		<p>HLK-PM03 AC-DC Power Supply Module 220v to 3.3v</p>	
NA531		<p>HLK-PM12 AC-DC Power Supply Module 220v to 12v</p>	
NA532		<p>HLK-5M05 AC-DC Power Supply Module 220v to 5v</p>	







NA533	 <p>HLK-5M12 AC-DC Power Supply Module 220v to 12v</p>	<p>HLK-5M12 AC-DC Power Supply Module 220v to 12v</p>	
NA534	 <p>HLK-2M05 AC-DC Power Supply Module 220v to 5v</p>	<p>HLK-2M05 AC-DC Power Supply Module 220v to 5v</p>	
AA671	 <p>ZFX-M301 AC-DC Switching Power Module AC100-240V DC12V 300MA</p>	<p>ZFX-M301 AC100-240V DC12V 300MA Switching Power Module</p>	
AA672	 <p>ZFX-M302 AC-DC Switching Power Module AC100-240V DC12V 550MA</p>	<p>ZFX-M302 AC100-240V DC12V 550MA Switching Power Module</p>	
AA673	 <p>ZFX-M303 AC-DC Switching Power Module AC100-240V DC5V 1A</p>	<p>ZFX-M303 AC100-240V DC5V 1A Switching Power Module</p>	
DE001	 <p>HLK-PM24 AC-DC Power Supply Module 220V to 24V</p>	<p>HLK-PM24 AC-DC 220V to 24V Power Supply Module</p>	20







DE114	 <p>HLK-1D1205(12V to 5V)</p>	<p>HLK-1D1205 DC-DC 12V to 5V Power Supply Module (New Model:B1205S-1WR3)</p>	20
DE115	 <p>HLK-1D1212(12V to 12V)</p>	<p>HLK-1D1212 DC-DC 12V to 12V Power Supply Module (New Model:B1212S-1WR3)</p>	20
DE116	 <p>HLK-1D2405(24V to 5V)</p>	<p>HLK-1D2405 DC-DC 24V to 5V Power Supply Module (New Model:B2405S-1WR3)</p>	20
DE117		<p>HLK-5D1205 DC-DC 9-18V to 5V Power Supply Module (New Model:VRB1205YMD-5WR3)</p>	20
DE118		<p>HLK-5D1212 DC-DC 9-18V to 12V Power Supply Module (New Model:VRB1212YMD-5WR3)</p>	20
DE119		<p>HLK-5D2405 DC-DC 18-36V to 5V Power Supply Module (New Model:VRB2405YMD-5WR3)</p>	20





DE120		<p>HLK-5D2412 DC-DC 24V to 12V Power Supply Module (New Model:VRB2412YMD-5WR3)</p>	20
DE121		<p>HLK-20D2405 DC-DC 9-36V to 5V Power Supply Module (New Model:URB2405YMD-20WR3)</p>	20
DE122		<p>HLK-20D2405C DC-DC 9-38V to 5V Power Supply Module (New Model:URB2405LD-20WR3)</p>	20
DE123		<p>HLK-20D2412C DC-DC 9-38V to 12V Power Supply Module</p>	20
DE002		<p>HLK-2M03 AC-DC 220V to 3.3V Power Supply Module</p>	20
DE003		<p>HLK-2M09 AC-DC 220V to 9V Power Supply Module</p>	20







DE004		HLK-2M12 AC-DC 220V to 12V Power Supply Module	20
DE005	 <p>AC 220V to DC 3.3V(5W)</p>	HLK-5M03 AC-DC 220V to 3.3V Power Supply Module	20
DE006	 <p>AC 220V to DC 5V(5W)</p>	HLK-5M05 AC-DC 220V to 5V Power Supply Module	停用， 与 NA532 重复
DE007		HLK-5M09 AC-DC 220V to 9V Power Supply Module	20
DE008	 <p>HLK-5M24 5W AC220V to DC24V/0.2A</p>	HLK-5M24 AC-DC 220V to 24V Power Supply Module	20
DE163		HLK-10M03 AC-DC 220V to 3.3V Power Supply Module	40

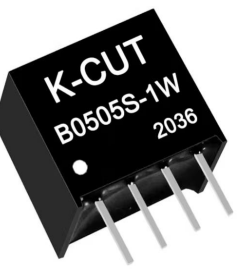



DE009	 <p>HLK-10M05 AC-DC 220V to 5V Power Supply Module</p>	20
DE164	 <p>HLK-10M09 AC-DC 220V to 9V Power Supply Module</p>	40
DE010	 <p>HLK-10M12 AC-DC 220V to 12V Power Supply Module</p>	20
DE165	 <p>HLK-10M15 AC-DC 220V to 15V Power Supply Module</p>	40
DE166	 <p>HLK-10M24 AC-DC 220V to 24V Power Supply Module</p>	40
DE011	 <p>HLK-20M05 20W AC220V to DC5V/4A</p>	20



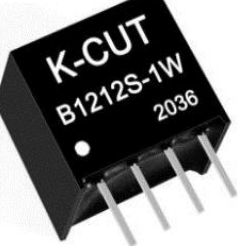

DE012	 <p>HLK-20M09 20W AC220V to DC9V/1.3A</p>	<p>HLK-20M09 AC-DC 220V to 9V Power Supply Module</p>	20
DE013		<p>HLK-20M12 AC-DC 220V to 12V Power Supply Module</p>	20
DE167		<p>HLK-20M15 AC-DC 220V to 15V Power Supply Module</p>	20
DE014		<p>HLK-20M24 AC-DC 220V to 24V Power Supply Module</p>	20
DE168	 <p>*内置EMC电路,直接过认证*</p>	<p>HLK-30M09C AC-DC 220V to 9V Power Supply Module</p>	40
DE169	 <p>*内置EMC电路,直接过认证*</p>	<p>HLK-30M12C AC-DC 220V to 12V Power Supply Module</p>	40





DE170	 <p>*内置EMC电路,直接过认证*</p>	<p>HLK-30M15C AC-DC 220V to 15V Power Supply Module</p>	40
DE171	 <p>*内置EMC电路,直接过认证*</p>	<p>HLK-30M24C AC-DC 220V to 24V Power Supply Module</p>	40
DE172	 <p>*氮化镓GaN方案/内置EMC电路*</p>	<p>HLK-30M09 AC-DC 220V to 9V Power Supply Module</p>	40
DE173	 <p>*氮化镓GaN方案/内置EMC电路*</p>	<p>HLK-30M12 AC-DC 220V to 12V Power Supply Module</p>	40
DE174	 <p>*氮化镓GaN方案/内置EMC电路*</p>	<p>HLK-30M15 AC-DC 220V to 15V Power Supply Module</p>	40
DE175	 <p>*氮化镓GaN方案/内置EMC电路*</p>	<p>HLK-30M24 AC-DC 220V to 24V Power Supply Module</p>	40



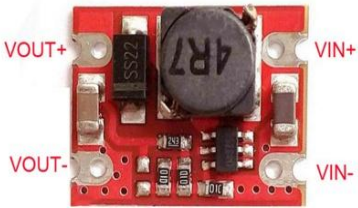
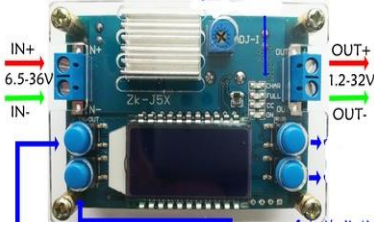

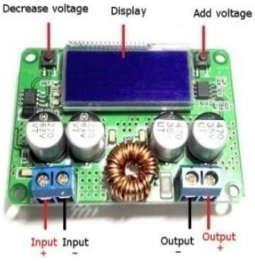
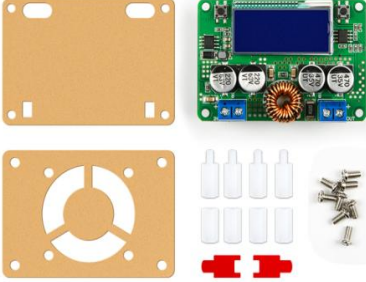

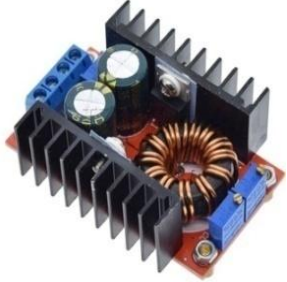
DE176	 <p>HLK-40M09 AC-DC Power Supply Module. Input: 100-240Vac, 1A 50-60Hz. Output: 9V=4.44A 40W. P/N: HLK-40M09. RoHS.</p>	<p>HLK-40M09 AC-DC 220V to 9V Power Supply Module</p>	40
DE177	 <p>HLK-40M12 AC-DC Power Supply Module. Input: 100-240Vac, 1A 50-60Hz. Output: 12V=3.33A 40W. P/N: HLK-40M12. RoHS.</p>	<p>HLK-40M12 AC-DC 220V to 12V Power Supply Module</p>	40
DE178	 <p>HLK-40M15 AC-DC Power Supply Module. Input: 100-240Vac, 1A 50-60Hz. Output: 15V=2.67A 40W. P/N: HLK-40M15. RoHS.</p>	<p>HLK-40M15 AC-DC 220V to 15V Power Supply Module</p>	40
DE179	 <p>HLK-40M24 AC-DC Power Supply Module. Input: 100-240Vac, 1A 50-60Hz. Output: 24V=1.67A 40W. P/N: HLK-40M24. RoHS.</p>	<p>HLK-40M24 AC-DC 220V to 24V Power Supply Module</p>	40
DE015	 <p>K-CUT B0503S-1W DC-DC Step-down Power Module. 2036.</p>	<p>K-CUT B0503S-1W DC- DC 5 to 3.3V Isolated Step-down Power Module</p>	4
DE016	 <p>K-CUT B0505S-1W DC-DC Isolated Power Module. 2036.</p>	<p>K-CUT B0505S-1W DC- DC 5 to 5V Isolated Power Module</p>	4



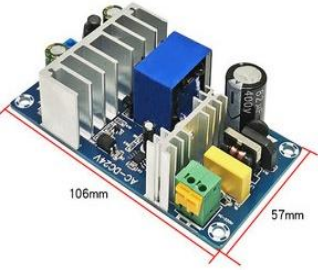

DE017		K-CUT B0509S-1W DC-DC 5 to 9V Isolated Booster Power Module	4
DE018		K-CUT B0512S-1W DC-DC 5 to 12V Isolated Booster Power Module	4
DE019		K-CUT B0515S-1W DC-DC 5 to 15V Isolated Booster Power Module	4
DE020		K-CUT B0524S-1W DC-DC 5 to 24V Isolated Booster Power Module	4
DE021		K-CUT B1203S-1W DC-DC 12 to 3.3V Isolated Step-down Power Module	4
DE022		K-CUT B1205S-1WR2 DC-DC 12 to 5V Isolated Step-down Power Module	4



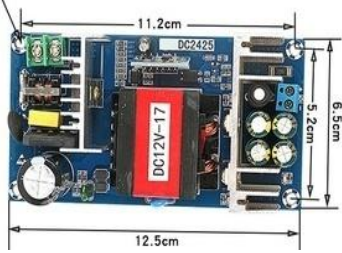

DE023		K-CUT B1209S-1W DC-DC 12 to 9V Isolated Step-down Power Module	4
DE024		K-CUT B1212S-1W DC-DC 12 to 12V Isolated Power Module	4
DE025		K-CUT B1215S-1W DC-DC 12 to 15V Isolated Booster Power Module	4
DE026		K-CUT B1224S-1W DC-DC 12 to 24V Isolated Booster Power Module	4
DE027		K-CUT B2403S-1W DC-DC 24 to 3.3V Isolated Step-down Power Module	4
DE028		K-CUT B2405S-1W DC-DC 24 to 5V Isolated Step-down Power Module	4







DE029		K-CUT B2409S-1W DC-DC 24 to 9V Isolated Step-down Power Module	4
DE030		K-CUT B2412S-1W DC-DC 24 to 12V Isolated Step-down Power Module	4
DE031		K-CUT B2415S-1W DC-DC 24 to 15V Isolated Step-down Power Module	4
DE032		K-CUT B2424S-1W DC-DC 24 to 24V Isolated Power Module	4
DE033		DC-DC 2V-5V to 5V Step Up Boost Power Supply Module	50
DE034		5A CNC DC-DC Step-down Power Supply Module <i>Note: Adjustable Constant Voltage Current, LCD, Multiple Display Keys to Set Voltage</i>	250

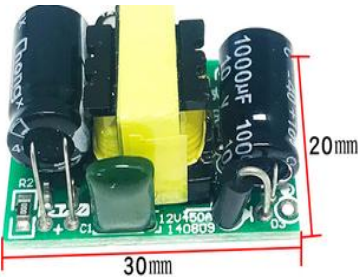

DE035		7A DC 60V Adjustable Step-Down Regulator, NC Power Supply Module, Current Voltage Meter, LCD Display (Without Case)	150
DE036		7A DC 60V Adjustable Step-Down Regulator, NC Power Supply Module, Current Voltage Meter, LCD Display (With Case)	160
DE037		24W 25W AC-DC AC-DC 100-265V to 12V 2A Switching Power Board	停用， 与 DE064 重复
DE038		70W AC-DC 110-245V to 12V 6A Switching Power Board	250
DE039		80W DC10-35 to 1-35V Automatic Voltage Up and Down Voltage Stabilized Constant Current Power Supply Module	50
DE040		100W AC-DC 85-265V to 12V 8A Switching Power Board	250

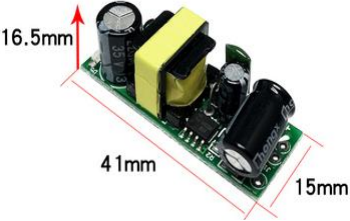



DE041	 <p>106mm 57mm</p>	<p>100W AC-DC 85V-265V to 24V 4A-6A Switching Power Board</p>	250
DE042		<p>120W DC-DC 10-32V to 35-60V Boost Converter, Car / Vehicle Power Supply Module</p> <p>Note: 10V is the limit value can not be used, the minimum 12V</p>	260
DE043		<p>120W AC-DC 90-265V to 24V 4A Switching Power Board</p>	250
DE044		<p>150W DC-DC 10-32V to 12-35V Boost Converter, Car / Vehicle Power Supply Module (Without Screw)</p>	260
DE045		<p>150W AC-DC AC-DC 100-260V to 12V 13A Switching Power Board</p>	250
DE046		<p>150W AC-DC AC-DC 110-260V to 12V 13A Switching Power Board</p>	与 DE045 重复，停用

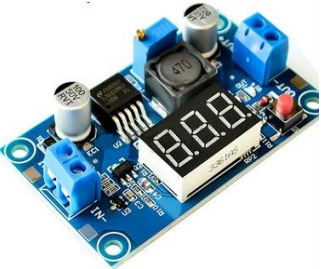
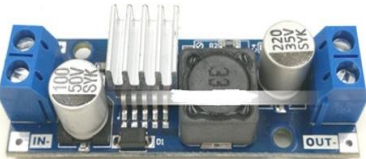
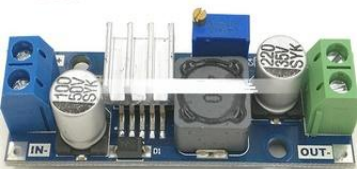

DE047		<p>180W AC-DC 110-220V to 36V 5A Switching Power Board</p>	250
DE048		<p>200W AC-DC 110-245V to 12V 17A Switching Power Board</p>	250
DE049		<p>220W AC-DC 110-245V to 24V 8A 9A 10A Switching Power Board</p>	250
DE050		<p>250W AC-DC 110-245V to 36V 7A Switching Power Board</p>	250
DE051		<p>1500W DC-DC 12-48V to 24-72V Boost Step Up Converter For Car Laptop Solar Battery</p>	350
DE052		<p>1800W 30A DC-DC High-Power Step-up Constant Voltage Constant Current Power Module</p>	100

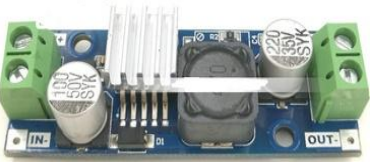

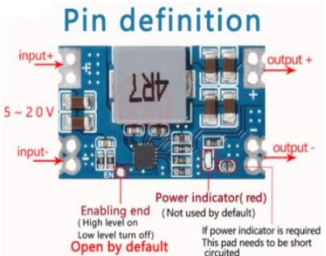

DE053	 <p>Fixed Output 3.3V/5V/9V/12V Adjustable power Module</p>	<p>MP1584EN DC-DC 3A 5V-12V 24V to 3.3V Step-down Power Supply Module</p>	3
DE054	 <p>Fixed Output 3.3V/5V/9V/12V Adjustable power Module</p>	<p>MP1584EN DC-DC 3A 5V-12V 24V to 5V Step- down Power Supply Module</p>	3
DE055	 <p>Fixed Output 3.3V/5V/9V/12V Adjustable power Module</p>	<p>MP1584EN DC-DC 3A 5V-12V 24V to 9V Step- down Power Supply Module</p>	3
DE056	 <p>Fixed Output 3.3V/5V/9V/12V Adjustable power Module</p>	<p>MP1584EN DC-DC 3A 5V-12V 24V to 12V Step- down Power Supply Module</p>	3
DE057		<p>DC-DC 1.8V-5V to 3.3V Booster and Buck Power Modules</p> <p>Note:Low Noise Regulated Charge Pump DC / DC Voltage Converter</p>	10
DE058	 <p>30mm 20mm</p>	<p>AC-DC 220V to 3.3V 600MA (2.5W) Switching Power Supply Step-Down Voltage Regulator Module</p>	80

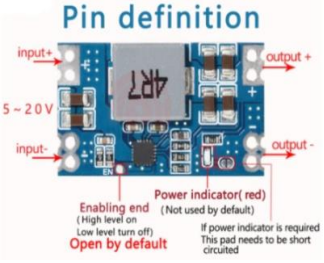
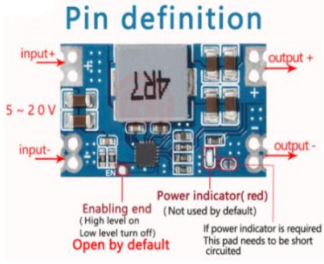
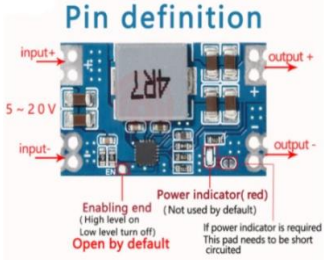

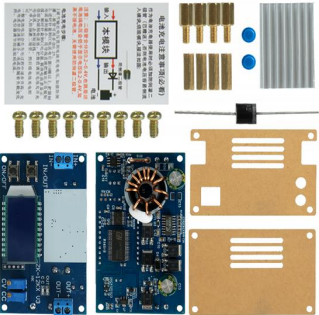

DE059	 <p>23.5mm 18mm</p>	<p>Precision AC-DC 220V to 5V 700MA-small (3.5W) Step Down Converter Power Supply Module Transformer</p>	80
DE060		<p>Precision AC-DC 220V to 9V 500MA (4.5W) Step Down Converter Power Supply Module Transformer</p>	80
DE061	 <p>16.5mm 41mm 15mm</p>	<p>Precision AC-DC 220V to 24V 200MA (5W) Step Down Converter Power Supply Module Transformer</p>	80
DE062		<p>220V to 5V 2A AC-DC Converter, Low Wave Power Supply Switch Module</p>	100
DE063		<p>AC-DC 12V 1A Switching Power Supply Module</p>	40
DE064		<p>AC-DC 12V 2A Switching Power Supply Module</p>	50



DE065		<p>AC-DC 12V 8A Switching Power Supply Module</p>	<p>停用， 与 DE040 重复</p>
DE066		<p>AC-DC 24V 1A Switching Power Supply Module</p>	<p>50</p>
DE067		<p>DC-DC 48V 36V to 24V 19V 15A High Efficiency Adjustable Regulator Converter Power Module</p>	<p>80</p>
DE068		<p>LM2596 DC-DC Adjustable Step-down Module with Digital Display Voltmeter (Red Button Switch)</p>	<p>40</p>
DE069		<p>LM2596 LM2576 DC-DC 12V 24V to 5V DC Step-down Power Module</p>	<p>50</p>
DE070		<p>LM2596S DC-DC 24V 40V to 12V 9V 5V 3V Adjustable DC Step-down Power Module</p>	<p>50</p>

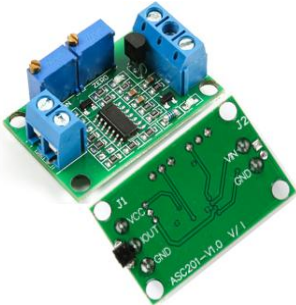

DE071		LM2596 DC-DC 24V 40V to 12V DC Step-down Power Module	50
DE072		D3806 CNC DC Stabilized Constant Current Power Supply, Adjustable Boost Module, 38V 6A Charger	250
DE073		LM7805 5V DC / AC Three Terminal Voltage Regulator Power	90
DE074		LM7806 6V DC / AC Three Terminal Voltage Regulator Power	90
DE075		LM7809 9V DC / AC Three Terminal Voltage Regulator Power	90
DE076		LM7812 12V DC / AC Three Terminal Voltage Regulator Power	90
DE141			24V-12V 9V to 5V Fixed Output, 3A Power Step-Down Adjustable Module (Chip is MP1584EN)
DE077	 <p>Pin definition</p> <p>input+ → 5 ~ 20V</p> <p>input- →</p> <p>output+ →</p> <p>output- →</p> <p>Power indicator (red) (Not used by default)</p> <p>Enabling end (High level on) (Low level turn off) Open by default</p> <p>If power indicator is required This pad needs to be short circuited</p>	MINI560 DC-DC 3.3V 5A Step-Down Stabilized Voltage Source Module Note: SMD Resistance Marked 64B Represents 3.3V	50

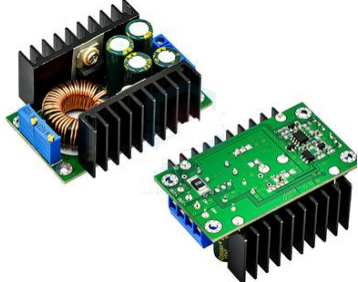
DE078		<p>MINI560 DC-DC 5V 5A Step-Down Stabilized Voltage Source Module</p> <p>Note:SMD Resistance Marked 85B Represents 5V</p>	50
DE079		<p>MINI560 DC-DC 9V 5A Step-Down Stabilized Voltage Source Module</p> <p>Note:SMD Resistance Marked 16C Represents 9V</p>	50
DE080		<p>MINI560 DC-DC 12V 5A Step-Down Stabilized Voltage Source Module</p> <p>Note:SMD Resistance Marked 28C Represents 12V</p>	50
DE081		<p>XL6019 DC-DC 5A Adjustable Boost Power Supply Module</p>	18
DE082		<p>2.8V-5.5V to ±12V DC Conversion Power Module</p>	45
DE083		<p>DC-DC 0-32V 12A Constant Current LCD Digital Display Adjustable Voltage Buck Step Down Power Supply Module Board (With Case)</p>	110

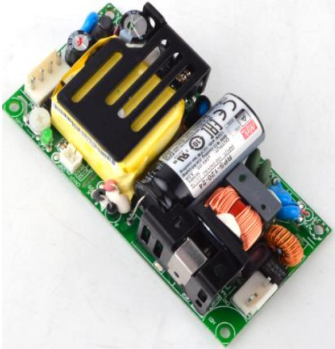
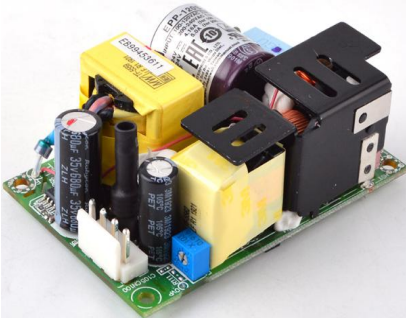
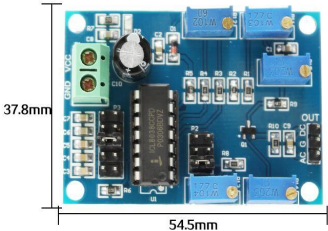



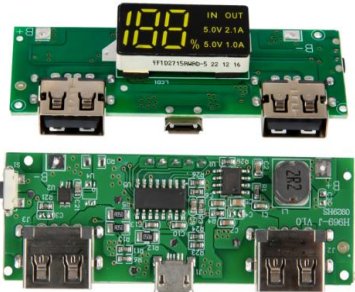
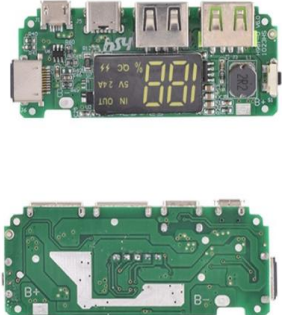

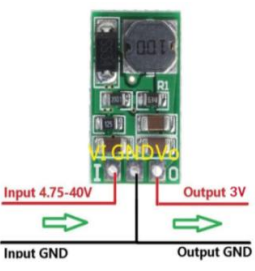
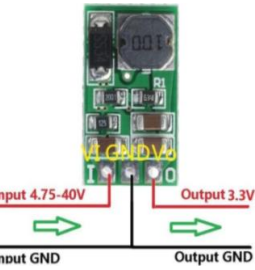
DE084	<p style="color: red; text-align: center;">DC 6-40V to DC 3.3V</p>  <p style="color: blue; text-align: center;">With Pin</p>	<p>3.3V DD38LOSA DC-DC Converter, Voltage Stabilization Device, Input DC6-40V 5W, Power Supply Module (With PIN and AMC1117)</p>	5
DE085	<p style="color: red; text-align: center;">DC 6-40V to DC 5V</p>  <p style="color: blue; text-align: center;">With Pin</p>	<p>5V DD38LOSA DC-DC Converter, Voltage Stabilization Device, Input DC6-40V 5W, Power Supply Module (With PIN and AMC1117)</p>	5
DE086	<p style="color: red; text-align: center;">DC 6-40V to DC 3.3V</p>  <p style="color: blue; text-align: center;">No Pin</p>	<p>3.3V DD38LOSA DC-DC Converter, Voltage Stabilization Device, Input DC6-40V 5W, Power Supply Module (Without PIN and AMC1117)</p>	5
DE087	<p style="color: red; text-align: center;">DC 6-40V to DC 5V</p>  <p style="color: blue; text-align: center;">No Pin</p>	<p>5V DD38LOSA DC-DC Converter, Voltage Stabilization Device, Input DC6-40V 5W, Power Supply Module (Without PIN and AMC1117)</p>	5
DE088	<p style="border: 1px solid black; padding: 2px; color: green; text-align: center;">3A 12V Lead-Acid Battery Charger</p> <p>Suitable for 1-1000AH 12V Lead-Acid Battery Power supply voltage : 15-25V Maximum charge current : 3A Overcurrent protection Automatic Recharge Battery Overvoltage Protection</p>	<p>HOT DD30CRTA Car Lead Acid Battery Charger 12V Charging Device 3A Current 1-10000AH UPS Solar Power Module (With Terminal)</p>	40
DE089		<p>HOT DD30CRTA Car Lead Acid Battery Charger 12V Charging Device 3A Current 1-10000AH UPS Solar Power Module (Without Terminal)</p>	40

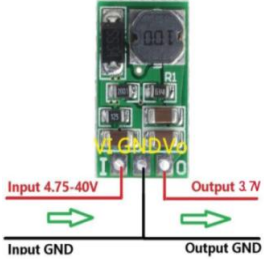
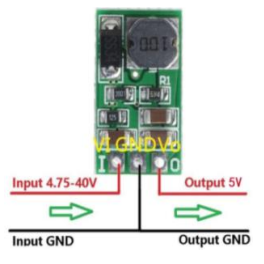
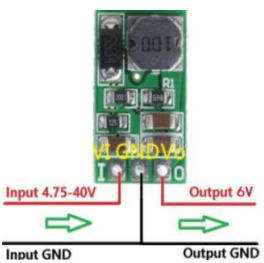
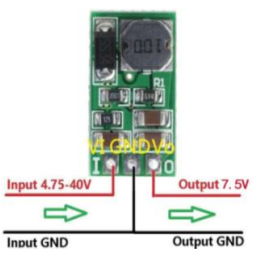
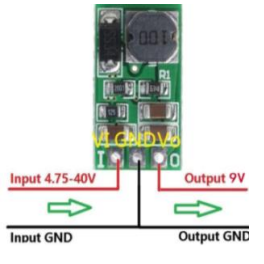
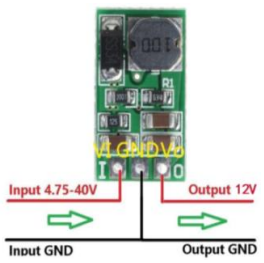



DE090		<p>HOT LTC3780 DC-DC 5V-32V to 1V-30V 10A Constant Voltage Current Automatic Step- down Regulator Charging Module (With Black Heatsink)</p>	300
DE091		<p>HOT LTC3780 DC-DC 5V-32V to 1V-30V 10A Constant Voltage Current Automatic Step- down Regulator Charging Module (With Gold Heatsink)</p>	300
DE092		<p>GOSLING 0-5V to 4- 20MA Voltage-to- Current Module</p>	停产
DE097		<p>DC-DC 5A Step-Down Constant Voltage Constant Current MPPT</p>	100
DE093		<p>DC-DC DC5-30V to 1.25- 30V 8A Power Module with Adjustable Voltage and Constant Voltage and Constant Current</p>	150
DE157		<p>DC-DC Buck Converter Step Down Power Supply Module 7-32V to 0.8-28V 12A 300W</p>	67



DE158		<p>DC-DC Voltage Converter Module 100W 12A Step Down</p>	67
DE159		<p>Original Taiwan MEAN WELL RPS-120-24 120W 24V 5A Power Supply</p>	150
DE160		<p>Original Taiwan MEAN WELL EPP-120S-24 120W 24V 5A Power Supply</p>	140
DE094		<p>ICL8038 12V to 15V Signal Generator Medium/Low Signal Frequency 10Hz- 450KHz Triangular/Rectangular/ Sine Wave Generator Module</p>	160
DE161		<p>Type-C Input QC2.0/3.0 Decoy Module Boost Trigger Motherboard 9V 12V 20V Adjustable Power Supply</p>	50
DE162		<p>USB Input QC2.0/3.0 Decoy Module Boost Trigger Motherboard 9V 12V 20V Adjustable Power Supply</p>	50

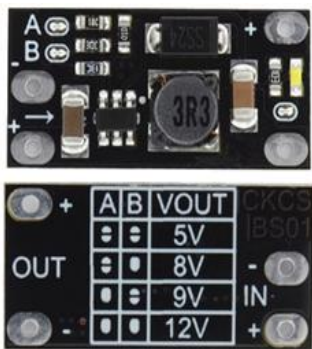

DE095		18650 5V 1A/2A Lithium Battery Digital Display Charging Module Dual USB Output Band Display Booster Mmodule	11
DE096		18650 5V 2.4A Lithium Battery Digital Display Charging Module Dual USB Output Band Display Booster Mmodule	11
DE155		3518 Chip Type-C USB QC4.0 PD3.0 6V-35V Mobile Phone Quick Fast Charge Adapter Module	12
DE156		3516 Chip Type-C USB QC4.0 QC3.0 6V-35V Mobile Phone Quick Fast Charge Adapter Module	12
DE098		DC-DC DC5-40V to 3V 1A Buck Step Down Converter Module Voltage Regulator Board without PIN	1.1
DE099		DC-DC DC5-40V to 3.3V 1A Buck Step Down Converter Module Voltage Regulator Board without PIN	1.1



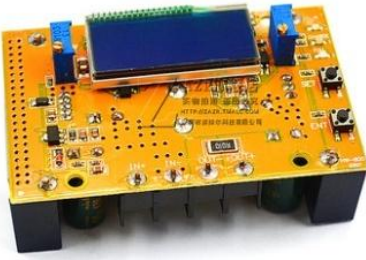
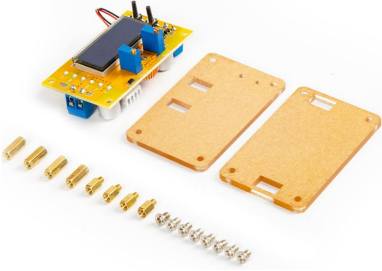
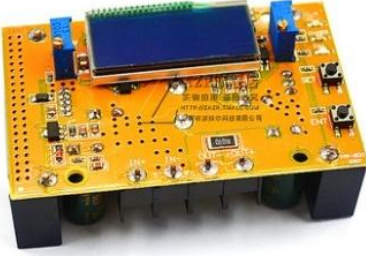

DE100	 <p>The diagram shows a green PCB with a silver electrolytic capacitor and various electronic components. Red arrows indicate the input voltage range of 4.75-40V and the output voltage of 3.7V. Green arrows show the flow of current from the input and output. Labels include 'Input 4.75-40V', 'Output 3.7V', 'Input GND', and 'Output GND'.</p>	<p>DC-DC DC5-40V to 3.7V 1A Buck Step Down Converter Module Voltage Regulator Board without PIN</p>	1.1
DE101	 <p>The diagram shows a green PCB with a silver electrolytic capacitor and various electronic components. Red arrows indicate the input voltage range of 4.75-40V and the output voltage of 5V. Green arrows show the flow of current from the input and output. Labels include 'Input 4.75-40V', 'Output 5V', 'Input GND', and 'Output GND'.</p>	<p>DC-DC DC5-40V to 5V 1A Buck Step Down Converter Module Voltage Regulator Board without PIN</p>	1.1
DE102	 <p>The diagram shows a green PCB with a silver electrolytic capacitor and various electronic components. Red arrows indicate the input voltage range of 4.75-40V and the output voltage of 6V. Green arrows show the flow of current from the input and output. Labels include 'Input 4.75-40V', 'Output 6V', 'Input GND', and 'Output GND'.</p>	<p>DC-DC DC5-40V to 6V 1A Buck Step Down Converter Module Voltage Regulator Board without PIN</p>	1.1
DE103	 <p>The diagram shows a green PCB with a silver electrolytic capacitor and various electronic components. Red arrows indicate the input voltage range of 4.75-40V and the output voltage of 7.5V. Green arrows show the flow of current from the input and output. Labels include 'Input 4.75-40V', 'Output 7.5V', 'Input GND', and 'Output GND'.</p>	<p>DC-DC DC5-40V to 7.5V 1A Buck Step Down Converter Module Voltage Regulator Board without PIN</p>	1.1
DE104	 <p>The diagram shows a green PCB with a silver electrolytic capacitor and various electronic components. Red arrows indicate the input voltage range of 4.75-40V and the output voltage of 9V. Green arrows show the flow of current from the input and output. Labels include 'Input 4.75-40V', 'Output 9V', 'Input GND', and 'Output GND'.</p>	<p>DC-DC DC5-40V to 9V 1A Buck Step Down Converter Module Voltage Regulator Board without PIN</p>	1.1
DE105	 <p>The diagram shows a green PCB with a silver electrolytic capacitor and various electronic components. Red arrows indicate the input voltage range of 4.75-40V and the output voltage of 12V. Green arrows show the flow of current from the input and output. Labels include 'Input 4.75-40V', 'Output 12V', 'Input GND', and 'Output GND'.</p>	<p>DC-DC DC5-40V to 12V 1A Buck Step Down Converter Module Voltage Regulator Board without PIN</p>	1.1

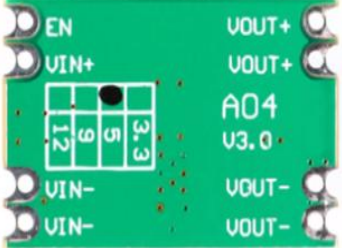
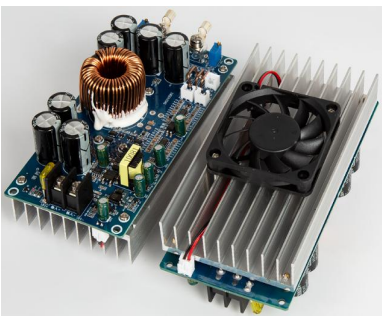
DE106		DC-DC DC5-40V to 3V 1A Buck Step Down Converter Module Voltage Regulator Board with 3PIN	1.3
DE107		DC-DC DC5-40V to 3.3V 1A Buck Step Down Converter Module Voltage Regulator Board with 3PIN	1.3
DE108		DC-DC DC5-40V to 3.7V 1A Buck Step Down Converter Module Voltage Regulator Board with 3PIN	1.3
DE109		DC-DC DC5-40V to 5V 1A Buck Step Down Converter Module Voltage Regulator Board with 3PIN	1.3
DE110		DC-DC DC5-40V to 6V 1A Buck Step Down Converter Module Voltage Regulator Board with 3PIN	1.3
DE111		DC-DC DC5-40V to 7.5V 1A Buck Step Down Converter Module Voltage Regulator Board with 3PIN	1.3

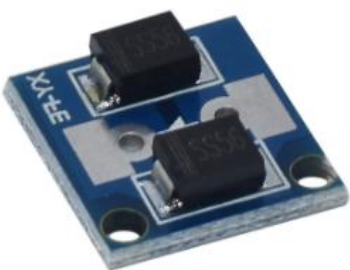
DE112		<p>DC-DC DC5-40V to 9V 1A Buck Step Down Converter Module Voltage Regulator Board with 3PIN</p>	1.3
DE113		<p>DC-DC DC5-40V to 12V 1A Buck Step Down Converter Module Voltage Regulator Board with 3PIN</p>	1.3
DE124		<p>3.7V to 12V Mini DC-DC Boost Step Up Converter Board Module 5V/ 8V/ 9V 12V Output MOQ5</p>	1.2
DE125		<p>XH-M122 TIP42C Linear Power Supply Board Constant Current Constant Voltage Module Adjustable Power Module Regulator AC /DC Input Voltage Regulation; 0-15V; Current Regulation: 0-1A</p>	缺货，暂不接单
DE126		<p>Dual Display 3A DC-DC 5-23V To 0-16.5V Step Down Power Supply Buck Converter Adjustable LCD Step-down Voltage Regulator Without Case</p>	50

DE127		Dual Display 3A DC-DC 5-23V To 0-16.5V Step Down Power Supply Buck Converter Adjustable LCD Step-down Voltage Regulator With Case	50
DE128		Dual Display 5A Power Adjustable Step-Down Constant-Voltage Constant-Current Power Module (Without Case)	135
DE129		Dual Display 5A Power Adjustable Step-Down Constant-Voltage Constant-Current Power Module (With Case)	145
DE138		Dual Display 10A Power Adjustable Step-Down Constant-Voltage Constant-Current Power Module (Without Case)	135
DE130		Dual Display 10A Power Adjustable Step-Down Constant-Voltage Constant-Current Power Module (With Case)	145
DE131		DC-DC DC8-55V to 3.3V 2A Step Down Buck Module Regulated Power Supply Module 2A High Current Circuit Board	20

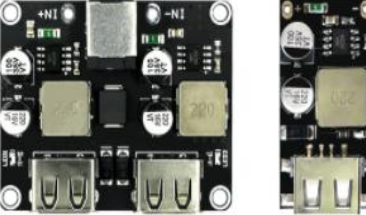
DE132		DC-DC DC8-55V to 5V 2A Step Down Buck Module Regulated Power Supply Module 2A High Current Circuit Board	20
DE133	<p>Input DC 8-55V Output DC 3.3V/5V/9V/12V</p> 	DC-DC DC8-55V to 9V 2A Step Down Buck Module Regulated Power Supply Module 2A High Current Circuit Board	20
DE134		DC-DC DC8-55V to 12V 2A Step Down Buck Module Regulated Power Supply Module 2A High Current Circuit Board	20
DE135		800W 30A DC-DC Step Down Buck Converter High Power CV CC Constant Current Adjustable MCU For Solar Power Charging Module	560
DE136		Green 60V 10A Anti- reverse Diode Constant-current Power Module Anti-reverse Irrigation Solar Anti- reverse Irrigation Anti- reverse Irrigation	3
DE137		Blue 60V 10A Anti- reverse Diode Constant-current Power Module Anti-reverse Irrigation Solar Anti- reverse Irrigation Anti- reverse Irrigation	3

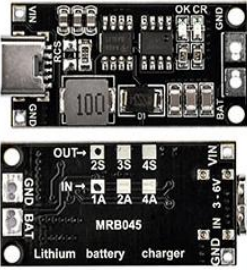
DE139		4 USB Port A5268 Step Down Voltage Regulator 4USB Buck Converter Power Transformer Supply DC36V 24V 12V 9V to 5V 3A For Hub Phone Auto Car	40
DE140		4 USB Port A5268 Step Down Voltage Regulator 4USB Buck Converter Power Transformer Supply DC12V 24V 40V to 5V 5A For Hub Phone Auto Car	停产
DE143		1 CHANNEL USB QC3.0 QC2.0 DC-DC Buck Converter Charging Step Down Module 6-32V 9V 12V 24V to Fast Quick Charger Circuit Board 2V 5V 12V	停用，与 NA592 重复
DE144		2 CHANNEL USB QC3.0 QC2.0 DC-DC Buck Converter Charging Step Down Module 6-32V 9V 12V 24V to Fast Quick Charger Circuit Board 2V 5V 12V	28
DE145		4 CHANNEL USB QC3.0 QC2.0 DC-DC Buck Converter Charging Step Down Module 6-32V 9V 12V 24V to Fast Quick Charger Circuit Board 2V 5V 12V	30
DE146	 <p style="text-align: center;">2S-1A</p>	18650 Polymer Lithium ion Charger Type C to 2S 8.4V 1A Booster Module	5

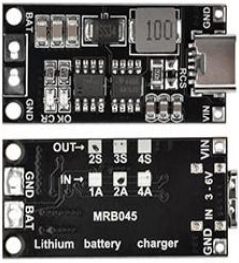
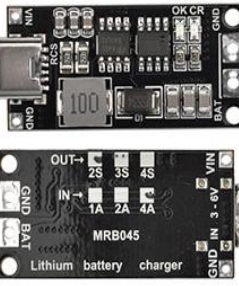
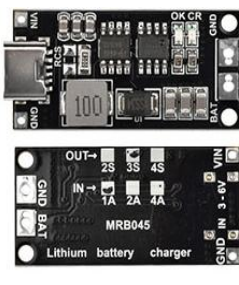
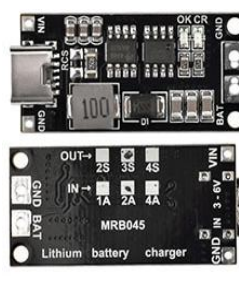
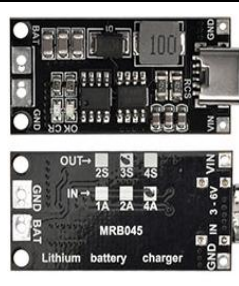
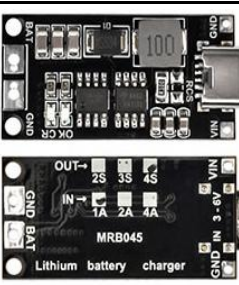
DE147	 <p style="text-align: center;">2S-2A</p>	<p>18650 Polymer Lithium ion Charger Type C to 2S 8.4V 2A Booster Module</p>	5
DE148	 <p style="text-align: center;">2S-4A</p>	<p>18650 Polymer Lithium ion Charger Type C to 2S 8.4V 4A Booster Module</p>	5
DE149	 <p style="text-align: center;">3S-1A</p>	<p>18650 Polymer Lithium ion Charger Type C to 3S 12.6V 1A Booster Module</p>	5
DE150	 <p style="text-align: center;">3S-2A</p>	<p>18650 Polymer Lithium ion Charger Type C to 3S 12.6V 2A Booster Module</p>	5
DE151	 <p style="text-align: center;">3S-4A</p>	<p>18650 Polymer Lithium ion Charger Type C to 3S 12.6V 4A Booster Module</p>	5
DE152	 <p style="text-align: center;">4S-1A</p>	<p>18650 Polymer Lithium ion Charger Type C to 4S 16.8V 1A Booster Module</p>	5

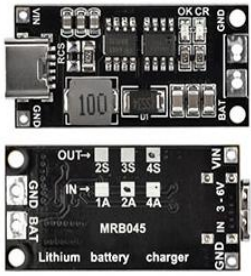
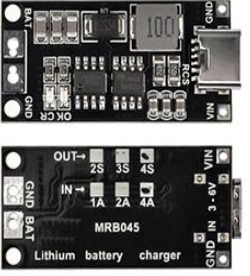
<p>DE153</p>	 <p>4S-2A</p>	<p>18650 Polymer Lithium ion Charger Type C to 4S 16.8V 2A Booster Module</p>	<p>5</p>
<p>DE154</p>	 <p>4S-4A</p>	<p>18650 Polymer Lithium ion Charger Type C to 4S 16.8V 4A Booster Module</p>	<p>5</p>