











Gear Motor 表1 (JB)







SKU	PICTURE	NAME	Weight (g)
AD016		<p>DC3-6V 130 Motor DIY</p> <p>Rotate Speed 20000rpm/min</p>	
AD122		<p>DC3V 130 Motor with Cable 15cm</p> <p>Rotate Speed 20000rpm/min</p>	
ND015		<p>DC12V N20 Micro Metal Gear Motor Pololu 100rpm</p>	
ND016		<p>DC12V N20 Micro Metal Gear Motor Pololu 600rpm 1:50</p>	
ND018		<p>25GA-370 3-9V DC Gear Motor 77rpm/min</p>	96
ND019		<p>25GA-370 3-9V DC Gear Motor 280rpm/min</p>	96

ND068		DC Motor 1.6KG 12V 130RPM 4mm Shaft	96
ND069		DC Motor 0.4KG 12V 250RPM 4mm Shaft	96
ND020		R140 3-6V DC Motor 25mm Length, 21mm Diameter	
ND067		DC 3-6V R260 Motor with Cable	
ND036	 <p>DC Gear Motor 77 rpm/min + Tyre L Shape Motor Bracket + Coupling</p>	Smart car Self- balancing Kits 65mm Wheel+77rpm/min Motor 6V+bracket+4mm Coupling (ND036-ND048-ND049	
ND037	 <p>DC Gear Motor 281rpm/min + Tyre L Shape Motor Bracket + Coupling</p>	Smart car Self- balancing Kits 65mm Wheel+281rpm/min Motor 6V+bracket+4mm Coupling (







<p>AD014</p>	 	<p>Robot Smart Car DC motor DIY 3-6V Grade A</p> <p>Reduction Ratio 1:48 Rotate Speed 125rpm/min</p>	
<p>AD092</p>		<p>Robot Smart Car DC motor DIY 3-6V Grade B</p> <p>Reduction Ratio 1:48 Rotate Speed 125rpm/min</p>	
<p>AD016</p>		<p>DC3-6V 130 Motor DIY</p> <p>Rotate Speed 20000rpm/min</p>	
<p>AD123</p>		<p>Single-shaft Robot Smart Car DC motor DIY 3V</p> <p>Reduction Ratio 1:48 Rotate Speed 125rpm/min</p>	
<p>AD122</p>		<p>DC3V 130 Motor with Cable 15cm</p> <p>Rotate Speed 20000rpm/min</p>	







AD017		<p>L Shape Single-shaft Robot Smart Car DC motor DIY 3-6V</p> <p>Reduction Ratio 1:48 Rotate Speed 125rpm/min</p>	
AD018		<p>L Shape Double-shaft Robot Smart Car DC motor DIY 3-6V</p> <p>Reduction Ratio 1:48 Rotate Speed 125rpm/min</p>	
JB241		<p>GA12-N20 3V 15RPM Micro DC Metal Gear Reduction Motor</p>	22
JB242		<p>GA12-N20 3V 25RPM Micro DC Metal Gear Reduction Motor</p>	22
JB243		<p>GA12-N20 3V 30RPM Micro DC Metal Gear Reduction Motor</p>	22
JB244		<p>GA12-N20 3V 35RPM Micro DC Metal Gear Reduction Motor</p>	22







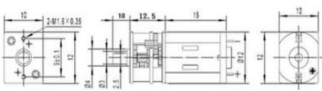

JB245		GA12-N20 3V 50RPM Micro DC Metal Gear Reduction Motor	22
JB246		GA12-N20 3V 60RPM Micro DC Metal Gear Reduction Motor	22
JB247		GA12-N20 3V 75RPM Micro DC Metal Gear Reduction Motor	22
JB248		GA12-N20 3V 100RPM Micro DC Metal Gear Reduction Motor	22
JB249		GA12-N20 3V 150RPM Micro DC Metal Gear Reduction Motor	22
JB250		GA12-N20 3V 200RPM Micro DC Metal Gear Reduction Motor	22

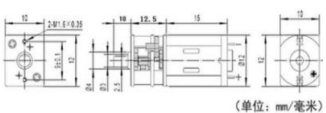

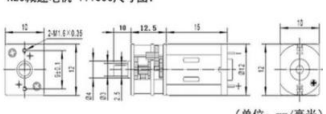

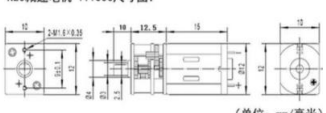

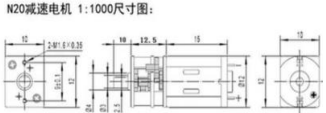
JB251		GA12-N20 3V 300RPM Micro DC Metal Gear Reduction Motor	22
JB252		GA12-N20 3V 400RPM Micro DC Metal Gear Reduction Motor	22
JB253		GA12-N20 3V 500RPM Micro DC Metal Gear Reduction Motor	22
JB254		GA12-N20 3V 600RPM Micro DC Metal Gear Reduction Motor	22
JB255		GA12-N20 3V 1000RPM 10:0 Micro DC Metal Gear Reduction Motor	22
JB256		GA12-N20 3V 2000RPM Micro DC Metal Gear Reduction Motor	22







JB257	 <p>N20减速电机 1:1000尺寸图: (单位: mm/毫米)</p>	<p>High Torque N20 6V 15RPM Micro DC Metal Gear Reduction Motor</p> <p>Reduction Ratio 1:1000</p>	22
JB258	 <p>N20减速电机 1:1000尺寸图: (单位: mm/毫米)</p>	<p>High Torque N20 6V 25RPM Micro DC Metal Gear Reduction Motor</p> <p>Reduction Ratio 1:1000</p>	22
JB259		<p>GA12-N20 6V 30RPM Micro DC Metal Gear Reduction Motor</p>	22
JB260		<p>GA12-N20 6V 35RPM Micro DC Metal Gear Reduction Motor</p>	22
JB261		<p>GA12-N20 6V 50RPM Micro DC Metal Gear Reduction Motor</p>	22
JB262		<p>GA12-N20 6V 60RPM Micro DC Metal Gear Reduction Motor</p>	22





JB263		GA12-N20 6V 70RPM Micro DC Metal Gear Reduction Motor	22
JB264		GA12-N20 6V 75RPM Micro DC Metal Gear Reduction Motor	22
JB265		GA12-N20 6V 100RPM Micro DC Metal Gear Reduction Motor	22
JB266		GA12-N20 6V 150RPM Micro DC Metal Gear Reduction Motor	22
JB267		GA12-N20 6V 200RPM Micro DC Metal Gear Reduction Motor	22
JB268		GA12-N20 6V 300RPM Micro DC Metal Gear Reduction Motor	22







JB269		GA12-N20 6V 400RPM Micro DC Metal Gear Reduction Motor	22
JB270		GA12-N20 6V 500RPM Micro DC Metal Gear Reduction Motor	22
JB271		GA12-N20 6V 600RPM Micro DC Metal Gear Reduction Motor	22
JB272		GA12-N20 6V 1000RPM 10:0 Micro DC Metal Gear Reduction Motor	22
JB273		GA12-N20 6V 2000RPM Micro DC Metal Gear Reduction Motor	22
JB274	 <p data-bbox="304 1899 456 1917">N20减速电机 1:1000尺寸图:</p>  <p data-bbox="536 2018 627 2036">(单位: mm/毫米)</p>	High Torque N20 12V 15RPM Micro DC Metal Gear Reduction Motor Reduction Ratio 1:1000	22







JB275	 <p>N20减速电机 1:1000尺寸图:</p>  <p>(单位: mm/毫米)</p>	<p>High Torque N20 12V 25RPM Micro DC Metal Gear Reduction Motor</p> <p>Reduction Ratio 1:1000</p>	22
JB276	 <p>N20减速电机 1:1000尺寸图:</p>  <p>(单位: mm/毫米)</p>	<p>High Torque N20 12V 30RPM Micro DC Metal Gear Reduction Motor</p> <p>Reduction Ratio 1:1000</p>	22
JB277	 <p>N20减速电机 1:1000尺寸图:</p>  <p>(单位: mm/毫米)</p>	<p>High Torque N20 12V 35RPM Micro DC Metal Gear Reduction Motor</p> <p>Reduction Ratio 1:1000</p>	22
JB278	 <p>N20减速电机 1:1000尺寸图:</p>  <p>(单位: mm/毫米)</p>	<p>High Torque N20 12V 50RPM Micro DC Metal Gear Reduction Motor</p> <p>Reduction Ratio 1:1000</p>	22
JB279		<p>GA12-N20 12V 60RPM Micro DC Metal Gear Reduction Motor</p>	22
JB280		<p>GA12-N20 12V 70RPM Micro DC Metal Gear Reduction Motor</p>	22







JB281		GA12-N20 12V 75RPM Micro DC Metal Gear Reduction Motor	22
JB282		GA12-N20 12V 100RPM Micro DC Metal Gear Reduction Motor	SKU重复, 停用, 有单请下 ND015
JB283		GA12-N20 12V 120RPM Micro DC Metal Gear Reduction Motor	22
JB284		GA12-N20 12V 140RPM Micro DC Metal Gear Reduction Motor	22
JB285		GA12-N20 12V 150RPM Micro DC Metal Gear Reduction Motor	22
JB286		GA12-N20 12V 200RPM Micro DC Metal Gear Reduction Motor	22







JB287		GA12-N20 12V 300RPM Micro DC Metal Gear Reduction Motor	22
JB288		GA12-N20 12V 400RPM Micro DC Metal Gear Reduction Motor	22
JB289		GA12-N20 12V 500RPM Micro DC Metal Gear Reduction Motor	22
JB290		GA12-N20 12V 600RPM Micro DC Metal Gear Reduction Motor	SKU重复，停用，有单请下ND016
JB291		GA12-N20 12V 1000RPM Micro DC Metal Gear Reduction Motor	22
JB292		GA12-N20 12V 1200RPM Micro DC Metal Gear Reduction Motor	22







JB293		<p>GA12-N20 12V 2000RPM Micro DC Metal Gear Reduction Motor</p>	22
JB294		<p>GA12-N20 12V 4000RPM Micro DC Metal Gear Reduction Motor</p>	22
JB295		<p>Pls Note Voltage and RPM when U Order Customized Other Parameters GA12-N20 3V/6V/12V Micro DC Metal Gear Reduction Motor (MOQ20) 3V, Minimum Customization RPM ≥ 15RPM; 6V, Minimum customization RPM ≥ 25RPM</p>	22
JB296		<p>GA12-N20 3V 15RPM Micro DC Reducer Motor Encoder with Wire</p>	25
JB297		<p>GA12-N20 3V 25RPM Micro DC Reducer Motor Encoder with Wire</p>	25







JB298		GA12-N20 3V 30RPM Micro DC Reducer Motor Encoder with Wire	25
JB299		GA12-N20 3V 35RPM Micro DC Reducer Motor Encoder with Wire	25
JB300		GA12-N20 3V 50RPM Micro DC Reducer Motor Encoder with Wire	25
JB301		GA12-N20 3V 60RPM Micro DC Reducer Motor Encoder with Wire	25
JB302		GA12-N20 3V 75RPM Micro DC Reducer Motor Encoder with Wire	25
JB303		GA12-N20 3V 100RPM Micro DC Reducer Motor Encoder with Wire	25







JB304		GA12-N20 3V 150RPM Micro DC Reducer Motor Encoder with Wire	25
JB305		GA12-N20 3V 200RPM Micro DC Reducer Motor Encoder with Wire	25
JB306		GA12-N20 3V 300RPM Micro DC Reducer Motor Encoder with Wire	25
JB307		GA12-N20 3V 500RPM Micro DC Reducer Motor Encoder with Wire	25
JB308		GA12-N20 3V 750RPM Micro DC Reducer Motor Encoder with Wire	25
JB309		GA12-N20 3V 1000RPM Micro DC Reducer Motor Encoder with Wire	25







JB310		GA12-N20 6V 15RPM Micro DC Reducer Motor Encoder with Wire	25
JB311		GA12-N20 6V 25RPM Micro DC Reducer Motor Encoder with Wire	25
JB312		GA12-N20 6V 30RPM Micro DC Reducer Motor Encoder with Wire	25
JB313		GA12-N20 6V 35RPM Micro DC Reducer Motor Encoder with Wire	25
JB314		GA12-N20 6V 50RPM Micro DC Reducer Motor Encoder with Wire	25
JB315		GA12-N20 6V 60RPM Micro DC Reducer Motor Encoder with Wire	25







JB316		<p>GA12-N20 6V 75RPM Micro DC Reducer Motor Encoder with Wire</p>	25
JB317		<p>GA12-N20 6V 100RPM Micro DC Reducer Motor Encoder with Wire</p>	25
JB318		<p>GA12-N20 6V 150RPM Micro DC Reducer Motor Encoder with Wire</p>	25
JB319		<p>GA12-N20 6V 200RPM Micro DC Reducer Motor Encoder with Wire</p>	25
JB320		<p>GA12-N20 6V 300RPM Micro DC Reducer Motor Encoder with Wire</p>	25
JB321		<p>GA12-N20 6V 500RPM Micro DC Reducer Motor Encoder with Wire</p>	25







JB322		GA12-N20 6V 750RPM Micro DC Reducer Motor Encoder with Wire	25
JB323		GA12-N20 6V 1000RPM Micro DC Reducer Motor Encoder with Wire	25
JB324		GA12-N20 12V 15RPM Micro DC Reducer Motor Encoder with Wire	25
JB325		GA12-N20 12V 25RPM Micro DC Reducer Motor Encoder with Wire	25
JB326		GA12-N20 12V 30RPM Micro DC Reducer Motor Encoder with Wire	25
JB327		GA12-N20 12V 35RPM Micro DC Reducer Motor Encoder with Wire	25



JB328		<p>GA12-N20 12V 50RPM Micro DC Reducer Motor Encoder with Wire</p>	25
JB329		<p>GA12-N20 12V 60RPM Micro DC Reducer Motor Encoder with Wire</p>	25
JB330		<p>GA12-N20 12V 75RPM Micro DC Reducer Motor Encoder with Wire</p>	25
JB331		<p>GA12-N20 12V 100RPM Micro DC Reducer Motor Encoder with Wire</p>	25
JB050		<p>GA12-N20 12V 120RPM Micro DC Reducer Motor Encoder with Wire</p>	25
JB051		<p>GA12-N20 12V 140RPM Micro DC Reducer Motor Encoder with Wire</p>	25







JB332		<p>GA12-N20 12V 150RPM Micro DC Reducer Motor Encoder with Wire</p>	25
JB333		<p>GA12-N20 12V 200RPM Micro DC Reducer Motor Encoder with Wire</p>	25
JB334		<p>GA12-N20 12V 300RPM Micro DC Reducer Motor Encoder with Wire</p>	25
JB335		<p>GA12-N20 12V 500RPM Micro DC Reducer Motor Encoder with Wire</p>	25
JB336		<p>GA12-N20 12V 750RPM Micro DC Reducer Motor Encoder with Wire</p>	25
JB337		<p>GA12-N20 12V 1000RPM Micro DC Reducer Motor Encoder with Wire</p>	25





JB338		<p>GA12-N20 12V 1200RPM Micro DC Reducer Motor Encoder with Wire</p>	25
JB339		<p>GA12-N20 12V 2000RPM Micro DC Reducer Motor Encoder with Wire</p>	25
JB340		<p>GA12-N20 12V 4000RPM Micro DC Reducer Motor Encoder with Wire</p>	25
JB341		<p>Pls Note Voltage and RPM when U Order Customized Other Parameters (MOQ20) GA12-N20 3V/6V/12V Micro DC Reducer Motor Encoder with Wire</p>	25
JB342		<p>25GA-370 6V 12RPM DC Reducer Gear Motor</p>	96
JB343		<p>25GA-370 6V 16RPM DC Reducer Gear Motor</p>	96







JB344		25GA-370 6V 26RPM DC Reducer Gear Motor	96
JB345		25GA-370 6V 35RPM DC Reducer Gear Motor	96
JB346		25GA-370 6V 60RPM DC Reducer Gear Motor	96
JB347		25GA-370 6V 130RPM DC Reducer Gear Motor	96
JB348		25GA-370 6V 150RPM DC Reducer Gear Motor	96
JB349		25GA-370 6V 200RPM DC Reducer Gear Motor	96







JB350		25GA-370 6V 400RPM DC Reducer Gear Motor	96
JB351		25GA-370 6V 620RPM DC Reducer Gear Motor	96
JB352		25GA-370 6V 1360RPM DC Reducer Gear Motor	96
JB353		25GA-370 12V 12RPM DC Reducer Gear Motor	96
JB354		25GA-370 12V 16RPM DC Reducer Gear Motor	96
JB355		25GA-370 12V 26RPM DC Reducer Gear Motor	96







JB356		25GA-370 12V 35RPM DC Reducer Gear Motor	96
JB357		25GA-370 12V 60RPM DC Reducer Gear Motor	96
JB358		25GA-370 12V 130RPM DC Reducer Gear Motor	SKU重复，停用，有单请下ND068
JB359		25GA-370 12V 150RPM DC Reducer Gear Motor	96
JB360		25GA-370 12V 200RPM DC Reducer Gear Motor	96
JB056		25GA-370 12V 280RPM DC Reducer Gear Motor	96







JB361		25GA-370 12V 400RPM DC Reducer Gear Motor	96
JB362		25GA-370 12V 620RPM DC Reducer Gear Motor	96
JB363		25GA-370 12V 1360RPM DC Reducer Gear Motor	96
JB364		25GA-370 24V 12RPM DC Reducer Gear Motor	96
JB365		25GA-370 24V 16RPM DC Reducer Gear Motor	96
JB366		25GA-370 24V 26RPM DC Reducer Gear Motor	96







JB367		25GA-370 24V 35RPM DC Reducer Gear Motor	96
JB368		25GA-370 24V 60RPM DC Reducer Gear Motor	96
JB369		25GA-370 24V 130RPM DC Reducer Gear Motor	96
JB370		25GA-370 24V 150RPM DC Reducer Gear Motor	96
JB371		25GA-370 24V 200RPM DC Reducer Gear Motor	96
JB057		25GA-370 24V 280RPM DC Reducer Gear Motor	96







JB372		25GA-370 24V 400RPM DC Reducer Gear Motor	96
JB373		25GA-370 24V 620RPM DC Reducer Gear Motor	96
JB374		25GA-370 24V 1360RPM DC Reducer Gear Motor	96
JB375		Pls Note Voltage and RPM when U Order Customized Other Parameters (MOQ20) 25GA-370 6V/12V/24V DC Reducer Gear Motor (Speed Range	96
JB440		25GA-370 6V 12RPM DC Reducer Gear Motor with Encoder	160
JB441		25GA-370 6V 16RPM DC Reducer Gear Motor with Encoder	160







JB442		25GA-370 6V 26RPM DC Reducer Gear Motor with Encoder	160
JB443		25GA-370 6V 35RPM DC Reducer Gear Motor with Encoder	160
JB444		25GA-370 6V 60RPM DC Reducer Gear Motor with Encoder	160
JB445		25GA-370 6V 130RPM DC Reducer Gear Motor with Encoder	160
JB446		25GA-370 6V 150RPM DC Reducer Gear Motor with Encoder	160
JB447		25GA-370 6V 200RPM DC Reducer Gear Motor with Encoder	160







JB448		25GA-370 6V 400RPM DC Reducer Gear Motor with Encoder	160
JB449		25GA-370 6V 620RPM DC Reducer Gear Motor with Encoder	160
JB450		25GA-370 6V 1360RPM DC Reducer Gear Motor with Encoder	160
JB451		25GA-370 12V 12RPM DC Reducer Gear Motor with Encoder	160
JB452		25GA-370 12V 16RPM DC Reducer Gear Motor with Encoder	160
JB453		25GA-370 12V 26RPM DC Reducer Gear Motor with Encoder	160







JB454		25GA-370 12V 35RPM DC Reducer Gear Motor with Encoder	160
JB455		25GA-370 12V 60RPM DC Reducer Gear Motor with Encoder	160
JB456		25GA-370 12V 130RPM DC Reducer Gear Motor with Encoder	160
JB457		25GA-370 12V 150RPM DC Reducer Gear Motor with Encoder	160
JB458		25GA-370 12V 200RPM DC Reducer Gear Motor with Encoder	160
JB459		25GA-370 12V 400RPM DC Reducer Gear Motor with Encoder	160







JB460		25GA-370 12V 620RPM DC Reducer Gear Motor with Encoder	160
JB461		25GA-370 12V 1360RPM DC Reducer Gear Motor with Encoder	160
JB462		25GA-370 24V 12RPM DC Reducer Gear Motor with Encoder	160
JB463		25GA-370 24V 16RPM DC Reducer Gear Motor with Encoder	160
JB464		25GA-370 24V 26RPM DC Reducer Gear Motor with Encoder	160
JB465		25GA-370 24V 35RPM DC Reducer Gear Motor with Encoder	160







JB466		25GA-370 24V 60RPM DC Reducer Gear Motor with Encoder	160
JB467		25GA-370 24V 130RPM DC Reducer Gear Motor with Encoder	160
JB468		25GA-370 24V 150RPM DC Reducer Gear Motor with Encoder	160
JB469		25GA-370 24V 200RPM DC Reducer Gear Motor with Encoder	160
JB470		25GA-370 24V 400RPM DC Reducer Gear Motor with Encoder	160
JB471		25GA-370 24V 620RPM DC Reducer Gear Motor with Encoder	160





JB472		<p>25GA-370 24V 1360RPM DC Reducer Gear Motor with Encoder</p>	160
JB473		<p>Pls Note Voltage and RPM when U Order Customized Other Parameters (MOQ20) 25GA-370 6V/12V/24V DC Reducer Gear Motor with Encoder</p>	160
JB001		<p>JGB37-520 DC6V 7RPM/MIN Miniature Forward and Reverse Brushed DC Speed Reducer Motor</p>	140
JB002		<p>JGB37-520 DC6V 12RPM/MIN Miniature Forward and Reverse Brushed DC Speed Reducer Motor</p>	140
JB003		<p>JGB37-520 DC6V 22RPM/MIN Miniature Forward and Reverse Brushed DC Speed Reducer Motor</p>	140
JB004		<p>JGB37-520 DC6V 35RPM/MIN Miniature Forward and Reverse Brushed DC Speed Reducer Motor</p>	140







JB005		<p>JGB37-520 DC6V 45RPM/MIN Miniature Forward and Reverse Brushed DC Speed Reducer Motor</p>	140
JB006		<p>JGB37-520 DC6V 66RPM/MIN Miniature Forward and Reverse Brushed DC Speed Reducer Motor</p>	140
JB007		<p>JGB37-520 DC6V 107RPM/MIN Miniature Forward and Reverse Brushed DC Speed Reducer Motor</p>	140
JB008		<p>JGB37-520 DC6V 200RPM/MIN Miniature Forward and Reverse Brushed DC Speed Reducer Motor</p>	140
JB009		<p>JGB37-520 DC6V 320RPM/MIN Miniature Forward and Reverse Brushed DC Speed Reducer Motor</p>	140
JB010		<p>JGB37-520 DC6V 600RPM/MIN Miniature Forward and Reverse Brushed DC Speed Reducer Motor</p>	140







JB011		<p>JGB37-520 DC6V 960RPM/MIN Miniature Forward and Reverse Brushed DC Speed Reducer Motor</p>	140
JB012		<p>JGB37-520 DC12V 7RPM/MIN Miniature Forward and Reverse Brushed DC Speed Reducer Motor</p>	140
JB013		<p>JGB37-520 DC12V 12RPM/MIN Miniature Forward and Reverse Brushed DC Speed Reducer Motor</p>	140
JB014		<p>JGB37-520 DC12V 15RPM/MIN Miniature Forward and Reverse Brushed DC Speed Reducer Motor</p>	140
JB015		<p>JGB37-520 DC12V 22RPM/MIN Miniature Forward and Reverse Brushed DC Speed Reducer Motor</p>	140
JB016		<p>JGB37-520 DC12V 25RPM/MIN Miniature Forward and Reverse Brushed DC Speed Reducer Motor</p>	140







JB017		<p>JGB37-520 DC12V 35RPM/MIN Miniature Forward and Reverse Brushed DC Speed Reducer Motor</p>	140
JB018		<p>JGB37-520 DC12V 45RPM/MIN Miniature Forward and Reverse Brushed DC Speed Reducer Motor</p>	140
JB019		<p>JGB37-520 DC12V 60RPM/MIN Miniature Forward and Reverse Brushed DC Speed Reducer Motor</p>	140
JB020		<p>JGB37-520 DC12V 66RPM/MIN Miniature Forward and Reverse Brushed DC Speed Reducer Motor</p>	140
JB021		<p>JGB37-520 DC12V 107RPM/MIN Miniature Forward and Reverse Brushed DC Speed Reducer Motor</p>	140
JB022		<p>JGB37-520 DC12V 200RPM/MIN Miniature Forward and Reverse Brushed DC Speed Reducer Motor</p>	140







JB023		<p>JGB37-520 DC12V 320RPM/MIN Miniature Forward and Reverse Brushed DC Speed Reducer Motor</p>	140
JB024		<p>JGB37-520 DC12V 600RPM/MIN Miniature Forward and Reverse Brushed DC Speed Reducer Motor</p>	140
JB498		<p>JGB37-520 DC12V 900RPM/MIN Miniature Forward and Reverse Brushed DC Speed Reducer Motor</p>	140
JB025		<p>JGB37-520 DC12V 960RPM/MIN Miniature Forward and Reverse Brushed DC Speed Reducer Motor</p>	140
JB026		<p>JGB37-520 DC24V 7RPM/MIN Miniature Forward and Reverse Brushed DC Speed Reducer Motor</p>	140
JB027		<p>JGB37-520 DC24V 12RPM/MIN Miniature Forward and Reverse Brushed DC Speed Reducer Motor</p>	140







JB028		<p>JGB37-520 DC24V 22RPM/MIN Miniature Forward and Reverse Brushed DC Speed Reducer Motor</p>	140
JB029		<p>JGB37-520 DC24V 35RPM/MIN Miniature Forward and Reverse Brushed DC Speed Reducer Motor</p>	140
JB030		<p>JGB37-520 DC24V 45RPM/MIN Miniature Forward and Reverse Brushed DC Speed Reducer Motor</p>	140
JB031		<p>JGB37-520 DC24V 66RPM/MIN Miniature Forward and Reverse Brushed DC Speed Reducer Motor</p>	140
JB032		<p>JGB37-520 DC24V 107RPM/MIN Miniature Forward and Reverse Brushed DC Speed Reducer Motor</p>	140
JB033		<p>JGB37-520 DC24V 200RPM/MIN Miniature Forward and Reverse Brushed DC Speed Reducer Motor</p>	140







JB034		<p>JGB37-520 DC24V 320RPM/MIN Miniature Forward and Reverse Brushed DC Speed Reducer Motor</p>	140
JB035		<p>JGB37-520 DC24V 600RPM/MIN Miniature Forward and Reverse Brushed DC Speed Reducer Motor</p>	140
JB036		<p>JGB37-520 DC24V 960RPM/MIN Miniature Forward and Reverse Brushed DC Speed Reducer Motor</p>	140
JB435		<p>550 DC24V 7000RPM/MIN Mini Brush DC Motor (Diameter 37MM)</p>	205
JB495		<p>550 DC6-24V Mini Brush DC Motor (Diameter 35MM) 6V 4000-5000RPM; 12V 8000RPM; 24V 16000RPM;</p>	200
JB436		<p>RS-385 DC6V 5000RPM/MIN Mini Brush DC Motor (Diameter 27.6MM)</p>	80







JB437		<p>RS-385 DC12V 10000RPM/MIN Mini Brush DC Motor (Diameter 27.6MM)</p>	80
JB438		<p>RS-385 DC24V 7000RPM/MIN Mini Brush DC Motor (Diameter 27.6MM)</p>	80
JB474		<p>Gear Shaft RS-385 DC24V 7000RPM/MIN Mini Brush DC Motor (Diameter 27.6MM) MOQ200</p>	80
JB439		<p>RS-385 DC24V 16000RPM/MIN Mini Brush DC Motor (Diameter 27.6MM)</p>	80
JB037		<p>DIY JGB37-520 6V 10RPM/MIN Encoder Motor Smart Car Kit (1*Gear Motor with Encoder+1*Bracket+1*4MM Coupling+1* 65mm Wheel+screws)</p>	220
JB038		<p>DIY JGB37-520 6V 30RPM/MIN Encoder Motor Smart Car Kit (1*Gear Motor with Encoder+1*Bracket+1*4MM Coupling+1* 65mm Wheel+screws)</p>	220



JB039	 <p>65MM</p>	<p>DIY JGB37-520 6V 166RPM/MIN Encoder Motor Smart Car Kit (1*Gear Motor with Encoder+1*Bracket+1*4MM Coupling+1* 65mm Wheel+screws)</p>	220
JB040	 <p>65MM</p>	<p>DIY JGB37-520 6V 265RPM/MIN Encoder Motor Smart Car Kit (1*Gear Motor with Encoder+1*Bracket+1*4MM Coupling+1* 65mm Wheel+screws)</p>	220
JB041	 <p>65MM</p>	<p>DIY JGB37-520 DC12V 12RPM/MIN Encoder Motor Smart Car Kit (1*Gear Motor with Encoder+1*Bracket+1*4MM Coupling+1* 65mm Wheel+screws)</p>	220
JB042	 <p>65MM</p>	<p>DIY JGB37-520 12V 20RPM/MIN Encoder Motor Smart Car Kit (1*Gear Motor with Encoder+1*Bracket+1*4MM Coupling+1* 65mm Wheel+screws)</p>	220
JB043	 <p>65MM</p>	<p>DIY JGB37-520 12V 37RPM/MIN Encoder Motor Smart Car Kit (1*Gear Motor with Encoder+1*Bracket+1*4MM Coupling+1* 65mm Wheel+screws)</p>	220
JB044	 <p>65MM</p>	<p>DIY JGB37-520 12V 60RPM/MIN Encoder Motor Smart Car Kit (1*Gear Motor with Encoder+1*Bracket+1*4MM Coupling+1* 65mm Wheel+screws)</p>	220



JB045		<p>DIY JGB37-520 12V 76RPM/MIN Encoder Motor Smart Car Kit (1*Gear Motor with Encoder+1*Bracket+1*4MM Coupling+1* 65mm Wheel+screws)</p>	220
JB046		<p>DIY JGB37-520 12V 110RPM/MIN Encoder Motor Smart Car Kit (1*Gear Motor with Encoder+1*Bracket+1*4MM Coupling+1* 65mm Wheel+screws)</p>	220
JB047		<p>DIY JGB37-520 12V 333RPM/MIN Encoder Motor Smart Car Kit (1*Gear Motor with Encoder+1*Bracket+1*4MM Coupling+1* 65mm Wheel+screws)</p>	220
JB048		<p>DIY JGB37-520 12V 1000RPM/MIN Encoder Motor Smart Car Kit (1*Gear Motor with Encoder+1*Bracket+1*4MM Coupling+1* 65mm Wheel+screws)</p>	220
JB049		<p>DIY JGB37-520 12V 1580RPM/MIN Encoder Motor Smart Car Kit (1*Gear Motor with Encoder+1*Bracket+1*4MM Coupling+1* 65mm Wheel+screws)</p>	220
JB060	 <p>JGB37-550 geared motor DC6V 12V 24V</p>	<p>JGB37-550 DC12V 10RPM/MIN High Torque High Power Brushed DC Reduction Motor (All Metal Gear)</p>	<p>停用此SKU，描述有误，实际为JGB37-555；有单请下载JB081</p>

JB062		<p>JGB37-555 DC12V 30RPM/MIN High Torque DC Low Speed Forward and Reverse Reduction Motor without Encode</p>	140
JB080		<p>JGB37-555 DC12V 6RPM/MIN High Torque DC Low Speed Forward and Reverse Reduction Motor without Encode</p>	140
JB081		<p>JGB37-555 DC12V 10RPM/MIN High Torque DC Low Speed Forward and Reverse Reduction Motor without Encode</p>	140
JB082		<p>JGB37-555 DC12V 19RPM/MIN High Torque DC Low Speed Forward and Reverse Reduction Motor without Encode</p>	140
JB083		<p>JGB37-555 DC12V 38RPM/MIN High Torque DC Low Speed Forward and Reverse Reduction Motor without Encode</p>	140
JB084		<p>JGB37-555 DC12V 56RPM/MIN High Torque DC Low Speed Forward and Reverse Reduction Motor without Encode</p>	140

JB085		JGB37-555 DC12V 89RPM/MIN High Torque DC Low Speed Forward and Reverse Reduction Motor without Encode	140
JB086		JGB37-555 DC12V 167RPM/MIN High Torque DC Low Speed Forward and Reverse Reduction Motor without Encode	140
JB087		JGB37-555 DC12V 265RPM/MIN High Torque DC Low Speed Forward and Reverse Reduction Motor without Encode	140
JB088		JGB37-555 DC12V 500RPM/MIN High Torque DC Low Speed Forward and Reverse Reduction Motor without Encode	140
JB089		JGB37-555 DC12V 800RPM/MIN High Torque DC Low Speed Forward and Reverse Reduction Motor without Encode	140
JB090		JGB37-555 DC24V 6RPM/MIN High Torque DC Low Speed Forward and Reverse Reduction Motor without Encode	140

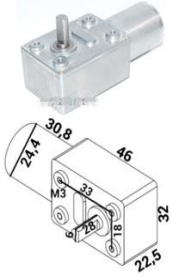
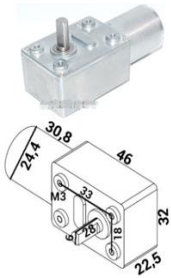
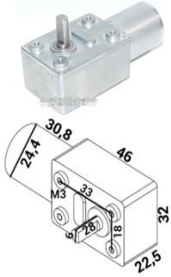
JB091		JGB37-555 DC24V 10RPM/MIN High Torque DC Low Speed Forward and Reverse Reduction Motor without Encode	140
JB092		JGB37-555 DC24V 19RPM/MIN High Torque DC Low Speed Forward and Reverse Reduction Motor without Encode	140
JB093		JGB37-555 DC24V 38RPM/MIN High Torque DC Low Speed Forward and Reverse Reduction Motor without Encode	140
JB094		JGB37-555 DC24V 56RPM/MIN High Torque DC Low Speed Forward and Reverse Reduction Motor without Encode	140
JB095		JGB37-555 DC24V 89RPM/MIN High Torque DC Low Speed Forward and Reverse Reduction Motor without Encode	140
JB096		JGB37-555 DC24V 167RPM/MIN High Torque DC Low Speed Forward and Reverse Reduction Motor without Encode	140

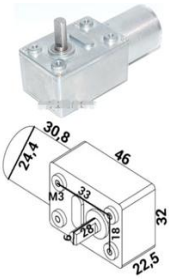
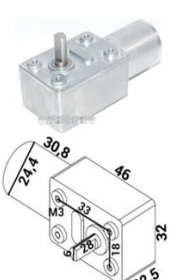
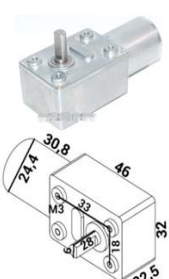
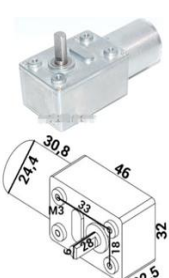

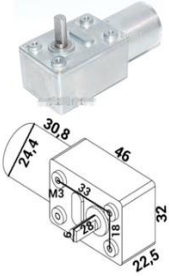
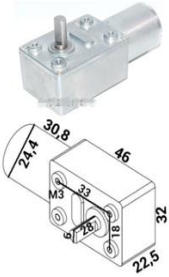
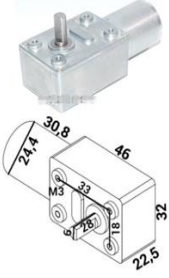
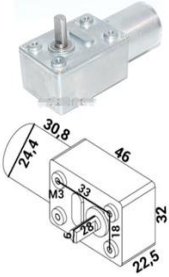
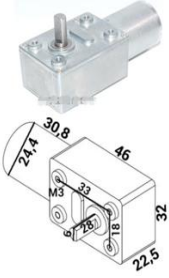
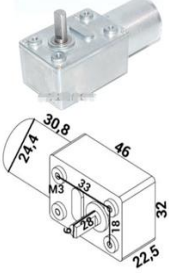

JB097		<p>JGB37-555 DC24V 265RPM/MIN High Torque DC Low Speed Forward and Reverse Reduction Motor without Encode</p>	140
JB098		<p>JGB37-555 DC24V 500RPM/MIN High Torque DC Low Speed Forward and Reverse Reduction Motor without Encode</p>	140
JB099		<p>JGB37-555 DC24V 800RPM/MIN High Torque DC Low Speed Forward and Reverse Reduction Motor without Encode</p>	140
JB100		<p>Solid Shaft JGY370 DC6V 2RPM/MIN High Torque Self-locking Strong Wheel Tturbine Worm Reduction Motor</p>	155
JB101		<p>Solid Shaft JGY370 DC6V 6RPM/MIN High Torque Self-locking Strong Wheel Tturbine Worm Reduction Motor</p>	155
JB102		<p>Solid Shaft JGY370 DC6V 10RPM/MIN High Torque Self- locking Strong Wheel Tturbine Worm Reduction Motor</p>	155





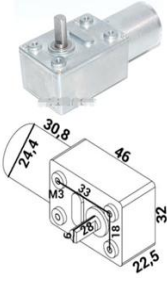
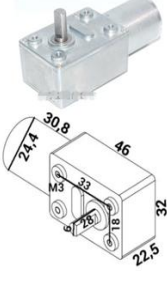

<p>JB103</p>		<p>Solid Shaft JGY370 DC6V 18RPM/MIN High Torque Self-locking Strong Wheel Tturbine Worm Reduction Motor</p>	<p>155</p>
<p>JB104</p>		<p>Solid Shaft JGY370 DC6V 23RPM/MIN High Torque Self-locking Strong Wheel Tturbine Worm Reduction Motor</p>	<p>155</p>
<p>JB105</p>		<p>Solid Shaft JGY370 DC6V 40RPM/MIN High Torque Self-locking Strong Wheel Tturbine Worm Reduction Motor</p>	<p>155</p>
<p>JB106</p>		<p>Solid Shaft JGY370 DC6V 66RPM/MIN High Torque Self-locking Strong Wheel Tturbine Worm Reduction Motor</p>	<p>155</p>
<p>JB107</p>		<p>Solid Shaft JGY370 DC6V 90RPM/MIN High Torque Self-locking Strong Wheel Tturbine Worm Reduction Motor</p>	<p>155</p>
<p>JB108</p>		<p>Solid Shaft JGY370 DC6V 150RPM/MIN High Torque Self-locking Strong Wheel Tturbine Worm Reduction Motor</p>	<p>155</p>







<p>JB109</p>		<p>Solid Shaft JGY370 DC12V 2RPM/MIN High Torque Self-locking Strong Wheel Tturbine Worm Reduction Motor</p>	<p>155</p>
<p>JB110</p>		<p>Solid Shaft JGY370 DC12V 3RPM/MIN High Torque Self-locking Strong Wheel Tturbine Worm Reduction Motor</p>	<p>155</p>
<p>JB111</p>		<p>Solid Shaft JGY370 DC12V 6RPM/MIN High Torque Self-locking Strong Wheel Tturbine Worm Reduction Motor</p>	<p>155</p>
<p>JB112</p>		<p>Solid Shaft JGY370 DC12V 10RPM/MIN High Torque Self-locking Strong Wheel Tturbine Worm Reduction Motor</p>	<p>155</p>
<p>JB113</p>		<p>Solid Shaft JGY370 DC12V 18RPM/MIN High Torque Self-locking Strong Wheel Tturbine Worm Reduction Motor</p>	<p>155</p>
<p>JB114</p>		<p>Solid Shaft JGY370 DC12V 23RPM/MIN High Torque Self-locking Strong Wheel Tturbine Worm Reduction Motor</p>	<p>155</p>







<p>JB115</p>		<p>Solid Shaft JGY370 DC12V 40RPM/MIN High Torque Self-locking Strong Wheel Tturbine Worm Reduction Motor</p>	<p>155</p>
<p>JB116</p>		<p>Solid Shaft JGY370 DC12V 55RPM/MIN High Torque Self-locking Strong Wheel Tturbine Worm Reduction Motor</p>	<p>155</p>
<p>JB117</p>		<p>Solid Shaft JGY370 DC12V 66RPM/MIN High Torque Self-locking Strong Wheel Tturbine Worm Reduction Motor</p>	<p>155</p>
<p>JB118</p>		<p>Solid Shaft JGY370 DC12V 90RPM/MIN High Torque Self-locking Strong Wheel Tturbine Worm Reduction Motor</p>	<p>155</p>
<p>JB119</p>		<p>Solid Shaft JGY370 DC12V 95RPM/MIN High Torque Self-locking Strong Wheel Tturbine Worm Reduction Motor</p>	<p>155</p>
<p>JB120</p>		<p>Solid Shaft JGY370 DC12V 150RPM/MIN High Torque Self-locking Strong Wheel Tturbine Worm Reduction Motor</p>	<p>155</p>







JB121		<p>Solid Shaft JGY370 DC12V 210RPM/MIN High Torque Self-locking Strong Wheel Tturbine Worm Reduction Motor</p>	155
JB122		<p>Solid Shaft JGY370 DC24V 2RPM/MIN High Torque Self-locking Strong Wheel Tturbine Worm Reduction Motor</p>	155
JB123		<p>Solid Shaft JGY370 DC24V 6RPM/MIN High Torque Self-locking Strong Wheel Tturbine Worm Reduction Motor</p>	155
JB124		<p>Solid Shaft JGY370 DC24V 10RPM/MIN High Torque Self-locking Strong Wheel Tturbine Worm Reduction Motor</p>	155
JB125		<p>Solid Shaft JGY370 DC24V 23RPM/MIN High Torque Self-locking Strong Wheel Tturbine Worm Reduction Motor</p>	155
JB126		<p>Solid Shaft JGY370 DC24V 66RPM/MIN High Torque Self-locking Strong Wheel Tturbine Worm Reduction Motor</p>	155







JB127		<p>Solid Shaft JGY370 DC24V 90RPM/MIN High Torque Self-locking Strong Wheel Tturbine Worm Reduction Motor</p>	155
JB128		<p>Solid Shaft JGY370 DC24V 150RPM/MIN High Torque Self-locking Strong Wheel Tturbine Worm Reduction Motor</p>	155
JB376		<p>Pls Note Voltage and RPM when U Order Customized Other Parameters (MOQ20) Solid Shaft JGY370 DC6/12/24V High Torque Self-locking Strong Wheel</p>	155
JB377		<p>Hollow Shaft JGY370 DC6V 2RPM/MIN High Torque Self-locking Strong Wheel Tturbine Worm Reduction Motor</p>	155
JB378		<p>Hollow Shaft JGY370 DC6V 6RPM/MIN High Torque Self-locking Strong Wheel Tturbine Worm Reduction Motor</p>	155
JB379		<p>Hollow Shaft JGY370 DC6V 10RPM/MIN High Torque Self-locking Strong Wheel Tturbine Worm Reduction Motor</p>	155







JB380		<p>Hollow Shaft JGY370 DC6V 18RPM/MIN High Torque Self-locking Strong Wheel Tturbine Worm Reduction Motor</p>	155
JB381		<p>Hollow Shaft JGY370 DC6V 23RPM/MIN High Torque Self-locking Strong Wheel Tturbine Worm Reduction Motor</p>	155
JB382		<p>Hollow Shaft JGY370 DC6V 40RPM/MIN High Torque Self-locking Strong Wheel Tturbine Worm Reduction Motor</p>	155
JB383		<p>Hollow Shaft JGY370 DC6V 66RPM/MIN High Torque Self-locking Strong Wheel Tturbine Worm Reduction Motor</p>	155
JB384		<p>Hollow Shaft JGY370 DC6V 90RPM/MIN High Torque Self-locking Strong Wheel Tturbine Worm Reduction Motor</p>	155
JB385		<p>Hollow Shaft JGY370 DC6V 150RPM/MIN High Torque Self-locking Strong Wheel Tturbine Worm Reduction Motor</p>	155







JB386		<p>Hollow Shaft JGY370 DC12V 2RPM/MIN High Torque Self-locking Strong Wheel Tturbine Worm Reduction Motor</p>	155
JB387		<p>Hollow Shaft JGY370 DC12V 6RPM/MIN High Torque Self-locking Strong Wheel Tturbine Worm Reduction Motor</p>	155
JB388		<p>Hollow Shaft JGY370 DC12V 10RPM/MIN High Torque Self-locking Strong Wheel Tturbine Worm Reduction Motor</p>	155
JB389		<p>Hollow Shaft JGY370 DC12V 18RPM/MIN High Torque Self-locking Strong Wheel Tturbine Worm Reduction Motor</p>	155
JB390		<p>Hollow Shaft JGY370 DC12V 23RPM/MIN High Torque Self-locking Strong Wheel Tturbine Worm Reduction Motor</p>	155
JB391		<p>Hollow Shaft JGY370 DC12V 40RPM/MIN High Torque Self-locking Strong Wheel Tturbine Worm Reduction Motor</p>	155







JB392		<p>Hollow Shaft JGY370 DC12V 66RPM/MIN High Torque Self-locking Strong Wheel Tturbine Worm Reduction Motor</p>	155
JB393		<p>Hollow Shaft JGY370 DC12V 90RPM/MIN High Torque Self-locking Strong Wheel Tturbine Worm Reduction Motor</p>	155
JB394		<p>Hollow Shaft JGY370 DC12V 150RPM/MIN High Torque Self-locking Strong Wheel Tturbine Worm Reduction Motor</p>	155
JB395		<p>Hollow Shaft JGY370 DC12V 210RPM/MIN High Torque Self-locking Strong Wheel Tturbine Worm Reduction Motor</p>	155
JB396		<p>Hollow Shaft JGY370 DC24V 2RPM/MIN High Torque Self-locking Strong Wheel Tturbine Worm Reduction Motor</p>	155
JB397		<p>Hollow Shaft JGY370 DC24V 6RPM/MIN High Torque Self-locking Strong Wheel Tturbine Worm Reduction Motor</p>	155







JB398		<p>Hollow Shaft JGY370 DC24V 10RPM/MIN High Torque Self-locking Strong Wheel Tturbine Worm Reduction Motor</p>	155
JB399		<p>Hollow Shaft JGY370 DC24V 18RPM/MIN High Torque Self-locking Strong Wheel Tturbine Worm Reduction Motor</p>	155
JB400		<p>Hollow Shaft JGY370 DC24V 23RPM/MIN High Torque Self-locking Strong Wheel Tturbine Worm Reduction Motor</p>	155
JB401		<p>Hollow Shaft JGY370 DC24V 40RPM/MIN High Torque Self-locking Strong Wheel Tturbine Worm Reduction Motor</p>	155
JB402		<p>Hollow Shaft JGY370 DC24V 66RPM/MIN High Torque Self-locking Strong Wheel Tturbine Worm Reduction Motor</p>	155
JB403		<p>Hollow Shaft JGY370 DC24V 90RPM/MIN High Torque Self-locking Strong Wheel Tturbine Worm Reduction Motor</p>	155



JB404		Hollow Shaft JGY370 DC24V 150RPM/MIN High Torque Self-locking Strong Wheel Tturbine Worm Reduction Motor	155
JB405		Hollow Shaft JGY370 DC24V 210RPM/MIN High Torque Self-locking Strong Wheel Tturbine Worm Reduction Motor	155
JB406		Pls Note Voltage and RPM when U Order Customized Other Parameters (MOQ20) Hollow Shaft JGY370 6V/12V/24V High Torque Self-locking	155
JB474		370 DC3-6V High Speed Large Torque Brushless DC Motor 3V No-load Speed 6000RPM; 6V No-load Speed 12000RPM;	48
JB407		37GB-3530 DC6V 35RPM/MIN Reduction Motor	200
JB408		37GB-3530 DC6V 45RPM/MIN Reduction Motor	200

JB409		37GB-3530 DC6V 66RPM/MIN Reduction Motor	200
JB410		37GB-3530 DC6V 107RPM/MIN Reduction Motor	200
JB411		37GB-3530 DC6V 200RPM/MIN Reduction Motor	200
JB412		37GB-3530 DC6V 320RPM/MIN Reduction Motor	200
JB413		37GB-3530 DC6V 600RPM/MIN Reduction Motor	200
JB414		37GB-3530 DC6V 960RPM/MIN Reduction Motor	200

JB415		37GB-3530 DC12V 35RPM/MIN Reduction Motor	200
JB416		37GB-3530 DC12V 45RPM/MIN Reduction Motor	200
JB417		37GB-3530 DC12V 66RPM/MIN Reduction Motor	200
JB418		37GB-3530 DC12V 107RPM/MIN Reduction Motor	200
JB419		37GB-3530 DC12V 200RPM/MIN Reduction Motor	200
JB420		37GB-3530 DC12V 320RPM/MIN Reduction Motor	200

JB421		37GB-3530 DC12V 531RPM/MIN Reduction Motor	200
JB422		37GB-3530 DC12V 600RPM/MIN Reduction Motor	200
JB423		37GB-3530 DC12V 960RPM/MIN Reduction Motor	200
JB424		37GB-3530 DC12V 1000RPM/MIN Reduction Motor	200
JB425		37GB-3530 DC24V 35RPM/MIN Reduction Motor	200
JB426		37GB-3530 DC24V 45RPM/MIN Reduction Motor	200



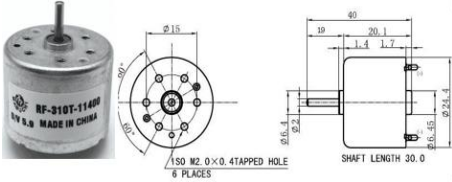
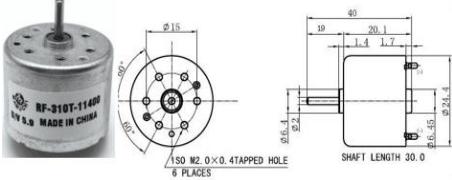
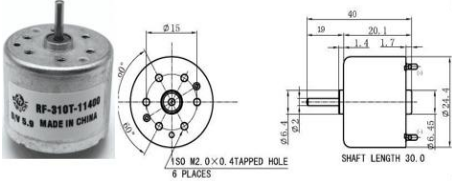
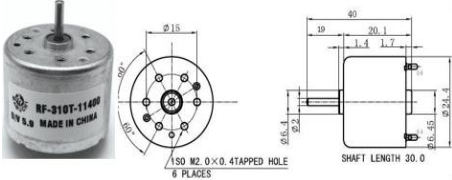

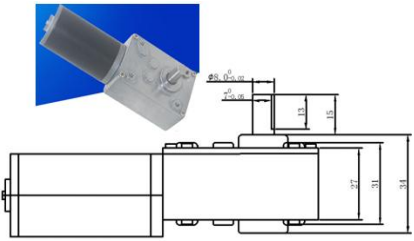
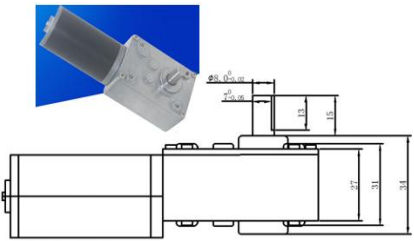
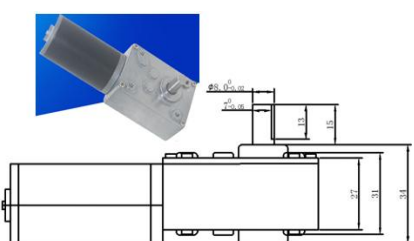
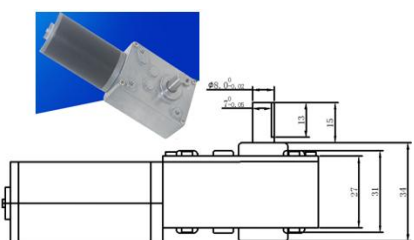
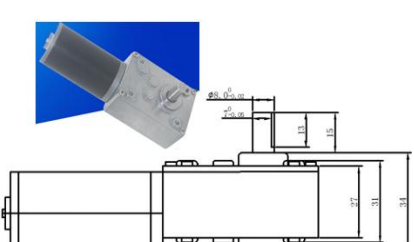
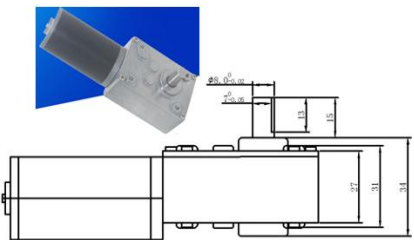

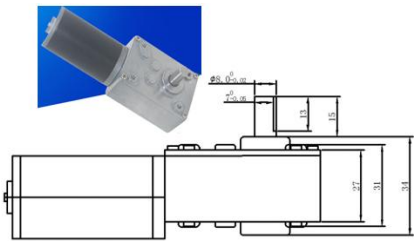
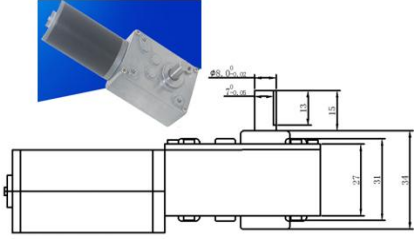
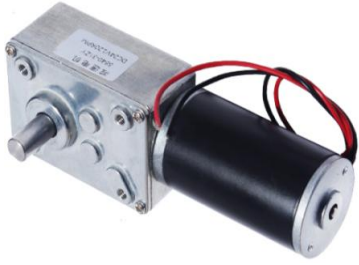
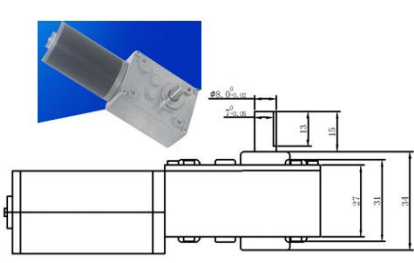
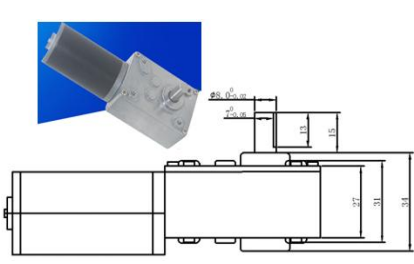
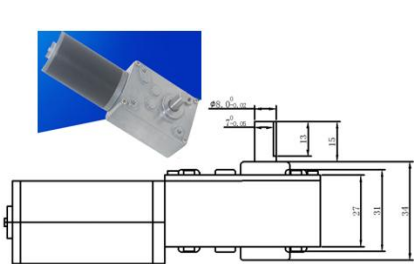
JB427		37GB-3530 DC24V 66RPM/MIN Reduction Motor	200
JB428		37GB-3530 DC24V 107RPM/MIN Reduction Motor	200
JB429		37GB-3530 DC24V 200RPM/MIN Reduction Motor	200
JB430		37GB-3530 DC24V 320RPM/MIN Reduction Motor	200
JB431		37GB-3530 DC24V 600RPM/MIN Reduction Motor	200
JB432		37GB-3530 DC24V 960RPM/MIN Reduction Motor	200







JB433		<p>Pls Note Voltage and RPM when U Order Customized Other Parameters (MOQ20) 37GB-3530 6V/12V/24V Reduction Motor</p>	200
JB434		<p>RS380-4045 3-9V General Purpose Micro DC Small Motor</p>	73
JB475		<p>RF-310T-11400 5.9V Miniature DC 310 Motor (6MM Shaft Length) Shaft Diameter: 2MM Body Diameter: 24MM Body Height: 18MM Mounting Holes: 6PCS</p>	30
JB476		<p>RF-310T-11400 5.9V Miniature DC 310 Motor (10MM Shaft Length) Shaft Diameter: 2MM Body Diameter: 24MM Body Height: 18MM Mounting Holes: 6PCS</p>	30
JB477		<p>RF-310T-11400 5.9V Miniature DC 310 Motor (22MM Shaft Length) Shaft Diameter: 2MM Body Diameter: 24MM Body Height: 18MM Mounting Holes: 6PCS</p>	30
JB478		<p>RF-310T-11400 5.9V Miniature DC 310 Motor (22MM Shaft Length) Shaft Diameter: 2MM Body Diameter: 24MM Body Height: 18MM Mounting Holes: 6PCS</p>	30







JB496		<p>D8MM Shaft 5840-31ZY 12V 10RPM/MIN High Torque Brushless DC Worm Gear Reduction Motor</p>	370
JB479		<p>D8MM Shaft 5840-31ZY 12V 12RPM/MIN High Torque Brushless DC Worm Gear Reduction Motor</p>	370
JB480		<p>D8MM Shaft 5840-31ZY 12V 16RPM/MIN High Torque Brushless DC Worm Gear Reduction Motor</p>	370
JB481		<p>D8MM Shaft 5840-31ZY 12V 27RPM/MIN High Torque Brushless DC Worm Gear Reduction Motor</p>	370
JB482		<p>D8MM Shaft 5840-31ZY 12V 40RPM/MIN High Torque Brushless DC Worm Gear Reduction Motor</p>	370
JB483		<p>D8MM Shaft 5840-31ZY 12V 80RPM/MIN High Torque Brushless DC Worm Gear Reduction Motor</p>	370







JB484		<p>D8MM Shaft 5840-31ZY 12V 160RPM/MIN High Torque Brushless DC Worm Gear Reduction Motor</p>	370
JB485		<p>D8MM Shaft 5840-31ZY 12V 250RPM/MIN High Torque Brushless DC Worm Gear Reduction Motor</p>	370
JB486		<p>D8MM Shaft 5840-31ZY 12V 470RPM/MIN High Torque Brushless DC Worm Gear Reduction Motor</p>	370
JB497		<p>D8MM Shaft 5840-31ZY 24V 10RPM/MIN High Torque Brushless DC Worm Gear Reduction Motor</p>	370
JB487		<p>D8MM Shaft 5840-31ZY 24V 12RPM/MIN High Torque Brushless DC Worm Gear Reduction Motor</p>	370
JB488		<p>D8MM Shaft 5840-31ZY 24V 16RPM/MIN High Torque Brushless DC Worm Gear Reduction Motor</p>	370







JB489		<p>D8MM Shaft 5840-31ZY 24V 27RPM/MIN High Torque Brushless DC Worm Gear Reduction Motor</p>	370
JB490		<p>D8MM Shaft 5840-31ZY 24V 40RPM/MIN High Torque Brushless DC Worm Gear Reduction Motor</p>	370
JB491		<p>D8MM Shaft 5840-31ZY 24V 80RPM/MIN High Torque Brushless DC Worm Gear Reduction Motor</p>	370
JB492		<p>D8MM Shaft 5840-31ZY 24V 160RPM/MIN High Torque Brushless DC Worm Gear Reduction Motor</p>	370
JB493		<p>D8MM Shaft 5840-31ZY 24V 250RPM/MIN High Torque Brushless DC Worm Gear Reduction Motor</p>	370
JB494		<p>D8MM Shaft 5840-31ZY 24V 470RPM/MIN High Torque Brushless DC Worm Gear Reduction Motor</p>	370







JB129	 <p>5840-3650</p>	<p>5840-3650 12V 7RPM/MIN Brushless DC Worm Gear Reduction Motor with Encoder</p>	380
JB130	 <p>5840-3650</p>	<p>5840-3650 12V 10RPM/MIN Brushless DC Worm Gear Reduction Motor with Encoder</p>	380
JB131	 <p>5840-3650</p>	<p>5840-3650 12V 16RPM/MIN Brushless DC Worm Gear Reduction Motor with Encoder</p>	380
JB132	 <p>5840-3650</p>	<p>5840-3650 12V 27RPM/MIN Brushless DC Worm Gear Reduction Motor with Encoder</p>	380
JB133	 <p>5840-3650</p>	<p>5840-3650 12V 40RPM/MIN Brushless DC Worm Gear Reduction Motor with Encoder</p>	380
JB134	 <p>5840-3650</p>	<p>5840-3650 12V 80RPM/MIN Brushless DC Worm Gear Reduction Motor with Encoder</p>	380







JB135	 <p>5840-3650</p>	<p>5840-3650 12V 160RPM/MIN Brushless DC Worm Gear Reduction Motor with Encoder</p>	380
JB136	 <p>5840-3650</p>	<p>5840-3650 12V 260RPM/MIN Brushless DC Worm Gear Reduction Motor with Encoder</p>	380
JB137	 <p>5840-3650</p>	<p>5840-3650 12V 470RPM/MIN Brushless DC Worm Gear Reduction Motor with Encoder</p>	380
JB138	 <p>5840-3650</p>	<p>5840-3650 24V 7RPM/MIN Brushless DC Worm Gear Reduction Motor with Encoder</p>	380
JB139	 <p>5840-3650</p>	<p>5840-3650 24V 10RPM/MIN Brushless DC Worm Gear Reduction Motor with Encoder</p>	380
JB140	 <p>5840-3650</p>	<p>5840-3650 24V 16RPM/MIN Brushless DC Worm Gear Reduction Motor with Encoder</p>	380







JB141	 <p>5840-3650</p>	<p>5840-3650 24V 27RPM/MIN Brushless DC Worm Gear Reduction Motor with Encoder</p>	380
JB142	 <p>5840-3650</p>	<p>5840-3650 24V 40RPM/MIN Brushless DC Worm Gear Reduction Motor with Encoder</p>	380
JB143	 <p>5840-3650</p>	<p>5840-3650 24V 80RPM/MIN Brushless DC Worm Gear Reduction Motor with Encoder</p>	380
JB144	 <p>5840-3650</p>	<p>5840-3650 24V 160RPM/MIN Brushless DC Worm Gear Reduction Motor with Encoder</p>	380
JB145	 <p>5840-3650</p>	<p>5840-3650 24V 260RPM/MIN Brushless DC Worm Gear Reduction Motor with Encoder</p>	380
JB146	 <p>5840-3650</p>	<p>5840-3650 24V 470RPM/MIN Brushless DC Worm Gear Reduction Motor with Encoder</p>	380







JB147		6438-520 DC12V 95RPM/MIN Brushed DC Speed Reducer Motor	200
JB148		6438-520 DC12V 95RPM/MIN Brushed DC Speed Reducer Motor with Encoder	缺货
JB149		6438-520 DC24V 55RPM/MIN Brushed DC Speed Reducer Motor	200
JB150		6438-520 DC24V 55RPM/MIN Brushed DC Speed Reducer Motor with Encoder	缺货
JB151		25GA310 DC6V 16RPM/MIN Deceleration Micro Motor (All Metal Gear)	150
JB152		25GA310 DC6V 22RPM/MIN Deceleration Micro Motor (All Metal Gear)	150







JB153		25GA310 DC6V 35RPM/MIN Deceleration Micro Motor (All Metal Gear)	150
JB154		25GA310 DC6V 60RPM/MIN Deceleration Micro Motor (All Metal Gear)	150
JB155		25GA310 DC6V 80RPM/MIN Deceleration Micro Motor (All Metal Gear)	150
JB156		25GA310 DC6V 100RPM/MIN Deceleration Micro Motor (All Metal Gear)	150
JB157		25GA310 DC6V 170RPM/MIN Deceleration Micro Motor (All Metal Gear)	150
JB158		25GA310 DC6V 380RPM/MIN Deceleration Micro Motor (All Metal Gear)	150







JB159		<p>25GA310 DC12V 16RPM/MIN Deceleration Micro Motor (All Metal Gear)</p>	150
JB160		<p>25GA310 DC12V 22RPM/MIN Deceleration Micro Motor (All Metal Gear)</p>	150
JB161		<p>25GA310 DC12V 35RPM/MIN Deceleration Micro Motor (All Metal Gear)</p>	150
JB162		<p>25GA310 DC12V 60RPM/MIN Deceleration Micro Motor (All Metal Gear)</p>	150
JB163		<p>25GA310 DC12V 80RPM/MIN Deceleration Micro Motor (All Metal Gear)</p>	150
JB164		<p>25GA310 DC12V 100RPM/MIN Deceleration Micro Motor (All Metal Gear)</p>	150







JB165		25GA310 DC12V 170RPM/MIN Deceleration Micro Motor (All Metal Gear)	150
JB166		25GA310 DC12V 380RPM/MIN Deceleration Micro Motor (All Metal Gear)	150
JB167		60GA775 DC12V 5RPM/MIN DC Reduction Motor	700
JB168		60GA775 DC12V 15RPM/MIN DC Reduction Motor	700
JB169		60GA775 DC12V 30RPM/MIN DC Reduction Motor	700
JB170		60GA775 DC12V 50RPM/MIN DC Reduction Motor	700







JB171		60GA775 DC12V 100RPM/MIN DC Reduction Motor	700
JB172		60GA775 DC24V 5RPM/MIN DC Reduction Motor	700
JB173		60GA775 DC24V 15RPM/MIN DC Reduction Motor	700
JB174		60GA775 DC24V 30RPM/MIN DC Reduction Motor	700
JB175		60GA775 DC24V 50RPM/MIN DC Reduction Motor	700
JB176		60GA775 DC24V 100RPM/MIN DC Reduction Motor	700

JB177		<p>60GA775 DC24V 200RPM/MIN DC Reduction Motor</p>	700
JB178		<p>Round Shaft 775 12V 12000 RPM/MIN High Speed High Torque DC Motor Dual Shaft</p>	350
JB179		<p>D Shaft 775 12V 3000 RPM/MIN High Speed High Torque DC Motor Dual Shaft</p>	350
JB180		<p>D Shaft 775 12V 4500 RPM/MIN High Speed High Torque DC Motor Dual Shaft</p>	350
JB181		<p>D Shaft 775 12V 6000 RPM/MIN High Speed High Torque DC Motor Dual Shaft</p>	350
JB182		<p>D Shaft 775 12V 10000 RPM/MIN High Speed High Torque DC Motor Dual Shaft</p>	350







JB183		D Shaft 775 12V 12000 RPM/MIN High Speed High Torque DC Motor Dual Shaft	350
JB184		D Shaft 775 24V 5500 RPM/MIN High Speed High Torque DC Motor Dual Shaft	350
JB185		D Shaft 775 24V 6000 RPM/MIN High Speed High Torque DC Motor Dual Shaft	360
JB186		D Shaft 775 24V 10000 RPM/MIN High Speed High Torque DC Motor Dual Shaft	350
JB187		16GA 16MM 12V 6RPM/MIN All-metal DC Reduction Motor	30
JB188		16GA 16MM 12V 15RPM/MIN All-metal DC Reduction Motor	30



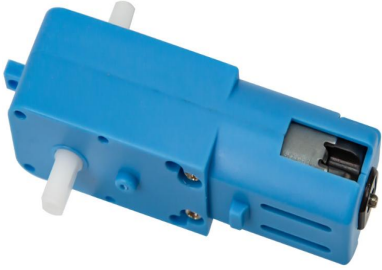

JB189		16GA 16MM 12V 30RPM/MIN All-metal DC Reduction Motor	30
JB190		16GA 16MM 12V 60RPM/MIN All-metal DC Reduction Motor	30
JB191		16GA 16MM 12V 100RPM/MIN All-metal DC Reduction Motor	30
JB192		16GA 16MM 12V 200RPM/MIN All-metal DC Reduction Motor	30
JB193		16GA 16MM 12V 300RPM/MIN All-metal DC Reduction Motor	30
JB194		MY1016Z 250W 12V DC Gear Brushed Motor	2500

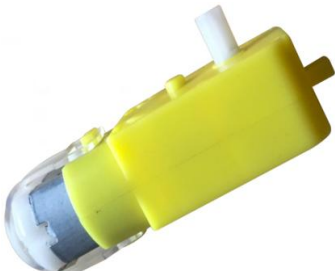

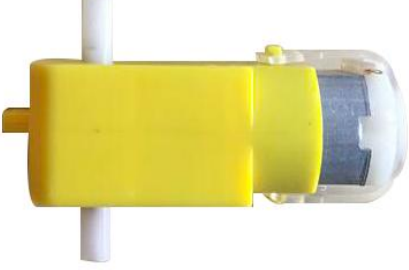

JB195		<p>MY1016Z 250W 24V DC Gear Brushed Motor</p>	2500
JB196		<p>MY1016Z 350W 24V DC Gear Brushed Motor</p>	2500
JB197	<p>24v 250w DC Brush</p> 	<p>MY1016 250W 24V DC Brushed Motor For Electric Bicycle Motor E-Scooter Ebike Belt Wheel Motor Kit Ebike Conversion Kit</p>	2000
JB198		<p>MY1016 350W 24V DC Brush Motor Ebike Mini Motorcycle Sprocket Motor Part</p>	2000
JB199		<p>MY1016 350W 36V DC Brush Motor Ebike Mini Motorcycle Sprocket Motor Part</p>	2000
JB200		<p>Sprocket MY6812 24V 150W Brush Motor with Belt Pulley Sprocket</p> <p>Note: For Electric Scooter Bicycle E-bike Unite Motor</p>	120

JB201		<p>GB6010 DC12-24V Brushless DC Outer Rotor Motor 12.6MM Large Hollow Design Pancake Motor without Encoder</p>	250
JB202		<p>GB6010+AS5048A DC12-24V Brushless DC Outer Rotor Motor 12.6MM Large Hollow Design Pancake Motor</p>	250
JB203		<p>GB6010+AS5600 DC12-24V Brushless DC Outer Rotor Motor 12.6MM Large Hollow Design Pancake Motor</p>	250
JB204		<p>Sector 775 DC12 4000RPM/MIN sector shape high speed strong vibration motor (With Vibrating Head)</p>	436
JB205		<p>Sector 775 DC24 8000RPM/MIN sector shape high speed strong vibration motor (With Vibrating Head)</p>	436
JB206		<p>Blue DC3V-6V 1:90 Metal Gear Motor Gear Motor Robot Intelligent Vehicle Speed Reducer TT Motor (Half Metal Single-shaft)</p>	40





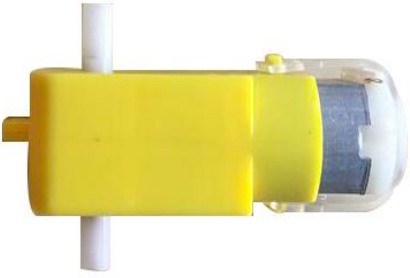
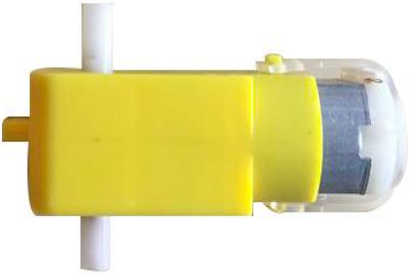

JB207		<p>Blue DC3V-6V 1:90 Metal Gear Motor Gear Motor Robot Intelligent Vehicle Speed Reducer TT Motor <i>(All Metal Single-shaft)</i></p>	40
JB208		<p>Blue DC3V-6V 1:90 Metal Gear Motor Gear Motor Robot Intelligent Vehicle Speed Reducer TT Motor <i>(Half Metal Dual-shaft)</i></p>	40
JB209		<p>Blue DC3V-6V 1:90 Metal Gear Motor Gear Motor Robot Intelligent Vehicle Speed Reducer TT Motor <i>(All Metal Dual-shaft)</i></p>	40
JB052		<p>Blue DC3V-6V 600RPM TT Motor Plastic Gear Motor Gearbox for Smart Robot Car <i>(1:48, Single-shaft)</i></p>	27
JB053		<p>Blue DC3V-6V 600RPM TT Motor Plastic Gear Motor Gearbox for Smart Robot Car <i>(1:48, Dual-shaft)</i></p>	27
JB054		<p>Blue DC3V-6V 200RPM TT Motor Plastic Gear Motor Gearbox for Smart Robot Car <i>(1:48, Single-shaft)</i></p>	27



JB055		Blue DC3V-6V 200RPM TT Motor Plastic Gear Motor Gearbox for Smart Robot Car (1:48, Dual-shaft)	27
JB210		Black Single-shaft DC3V-6V Smart Car Gear Motor Reduction Ratio 1:120 3V No-load Speed 50RPM MOQ100	30
JB211		White Single-shaft DC3V-6V Smart Car Gear Motor Reduction Ratio 1:120 3V No-load Speed 50RPM MOQ100	30
JB212		Black Single-shaft DC3V-6V Smart Car Gear Motor Reduction Ratio 1:220 3V No-load Speed 25RPM MOQ100	30
JB213		White Single-shaft DC3V-6V Smart Car Gear Motor Reduction Ratio 1:220 3V No-load Speed 25RPM MOQ100	30
JB214		Black Single-shaft DC3V-6V Smart Car Gear Motor Reduction Ratio 1:256 3V No-load Speed 20RPM MOQ100	30

JB215		<p>White Single-shaft DC3V-6V Smart Car Gear Motor Reduction Ratio 1:256 3V No-load Speed 20RPM MOQ100</p>	30
JB216		<p>L Shape Single-shaft DC3V-6V Smart Car Gear Motor Reduction Ratio 1:120 3V No-load Speed 50RPM MOQ100</p>	30
JB217		<p>Black Dual-shaft DC3V-6V Smart Car Gear Motor Reduction Ratio 1:120 3V No-load Speed 50RPM MOQ100</p>	30
JB218		<p>White Dual-shaft DC3V-6V Smart Car Gear Motor Reduction Ratio 1:120 3V No-load Speed 50RPM MOQ100</p>	30
JB219		<p>Single-shaft DC6V-9V Smart Car Gear Motor Reduction Ratio 1:48 9V No-load Speed 100RPM MOQ100</p>	40
JB220		<p>Single-shaft DC6V-9V Smart Car Gear Motor Reduction Ratio 1:48 9V No-load Speed 300RPM MOQ100</p>	40

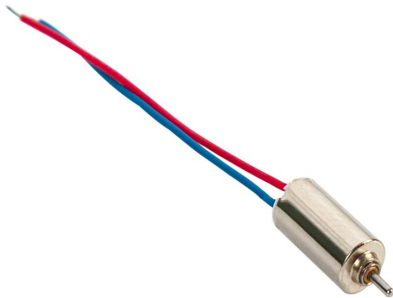
JB221		<p>Single-shaft DC6V-9V Smart Car Gear Motor Reduction Ratio 1:120 9V No-load Speed 60RPM MOQ100</p>	40
JB222		<p>L Shape Single-shaft DC6V-9V Smart Car Gear Motor Reduction Ratio 1:48 9V No-load Speed 100RPM MOQ100</p>	40
JB223		<p>L Shape Single-shaft DC6V-9V Smart Car Gear Motor Reduction Ratio 1:48 9V No-load Speed 150RPM MOQ100</p>	40
JB224		<p>L Shape Single-shaft DC6V-9V Smart Car Gear Motor Reduction Ratio 1:48 9V No-load Speed 300RPM MOQ100</p>	40
JB225		<p>Dual-shaft DC6V-9V Smart Car Gear Motor Reduction Ratio 1:48 9V No-load Speed 100RPM MOQ100</p>	40
JB226		<p>Dual-shaft DC6V-9V Smart Car Gear Motor Reduction Ratio 1:48 9V No-load Speed 300RPM MOQ100</p>	40

JB227		Black F2838-350KV Underwater Thruster Waterproof Motor for RC Boat Model RC Toy Accessory	100
JB228		FC-280SC 9Teeth Car Door Lock Micro Motor Vehicle Power Rearview Mirror Trunk Electric Engine Motors	42
JB229		50KTYZ-21 110V Egg Turning Motor	60
JB230		49TYJ-F 220V Mini Incubator Egg Turning Motor	60
JB231		300 Long Axis 12V 48RPM Reduction Motor	30
JB232		Clock 7 DC6V-12V 60- 120 R/MIN Worm Gear and Worm Reducer Motor Font DC Reduction Motor	停产, 下架

JB499		Clock 7 DC6V-12V 60-120 R/MIN Worm Gear and Worm Reducer Motor Font DC Reduction Motor (Right)	停产， 下架
JB233		Item 1 Mirco 300 Series Gear Motor DC3V-9V Small Speed Reducer 2.5-7.5RPM Short Long Shaft Slow Speed Note:No-load current: 20MA/sneed: 5RPM	28
JB234		Item 3 Mirco 300 Series Gear Motor DC3V-9V Small Speed Reducer 3.5-10.5RPM Short Long Shaft Slow Speed Note:No-load current: 40MA/sneed: 7RPM	29
JB235		12V 300 Long Axis DC Geared Motor	30
JB236		1.5-4.5V 10000RPM 408 Hollow Cup Motor (Random line color)	15
JB237		1.5V-3V 4*8MM Hollow Cup Miniature Micro DC 4X8 Vibration Motor (Red+Blue Wire about 20MM)	8

JB238		1.5V-3V 4*8MM Hollow Cup Miniature Micro DC 4X8 Vibration Motor with Transparent Tube (Red+Blue Wire about 10MM)	15
JB239		1.5V-3V 6*14MM Vibration Hollow Cup Motor (Red+Blue Wire about 45MM)	15
JB240		1.5V-5V 615 Hollow Cup Vibration Motor (Red+Blue Wire about 10MM) Note:High Vibration Force, Neodymium Iron Boron Strong Magnet	5